

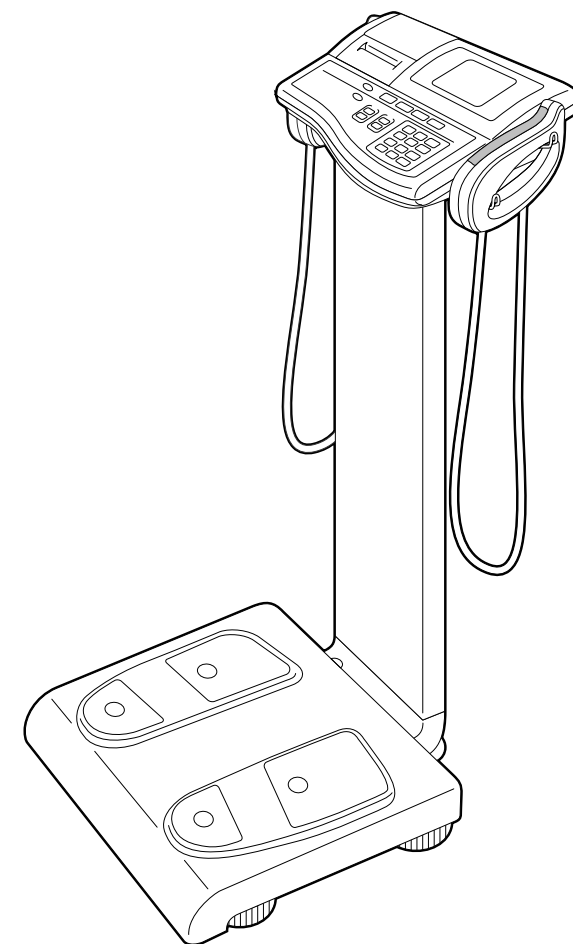

BODY COMPOSITION ANALYZER BC-418MA INSTRUCTION MANUAL



This equipment conforms to the following Safety Standards, the EMC Directive and the required items in the Medical Device Directive.

Safety Standard	: EN60601-1:1990, AM No.1:1993, AM No.2:1995 IEC60601-1:1988, AM No.1:1991, AM No.2:1995
EMC Standard	: EN-60601-1-2:1993 IEC60601-1-2:1993
Medical Device Directory Standard	: 93/42/EEC:1993

<Corporation Responsible in the EU Region>

TANITA UK LTD.

The Barn, Philpots Close, Yiewsley,
West Drayton, Middlesex,
UB7 7RY, United Kingdom
Tel : +44-1895-438577 Fax : +44-1895-438511

TANITA

TANITA Corporation

14-2,1-chome, Maeno-cho, Itabashi-ku
Tokyo, Japan
Tel: (03)3968-2123 / (03)3968-7048 Fax: (03)3967-3766

TANITA Corporation of America, inc.

2625 South Clearbrook Drive
Arlington Heights, Illinois 60005 U.S.A.
Toll Free : (800) 826-4828
Tel : 847-640-9241
Fax : 847-640-9261
http : //www.tanita.com

TANITA Health Equipment H.K.LTD.

Unit 301-303 3/F Wing On Plaza,
62 Mody Road, Tsimshatsui East,
Kowloon, Hong Kong
Tel : +852-2838-7111
Fax : +852-2838-8667

TANITA Europe GmbH

Dresdener Strasse 25
D-71065 Sindelfingen,
Germany
Tel : 07031-6189-6
Fax : 07031-6189-71

TANITA France S.A.

Villa Labrouste
68 Boulevard Bourdon,
92200 Neuilly-Sur-Seine,
France
Tel : 01 55 24 99 99
Fax : 01 55 24 98 68

BC4187011(1)

 **Please read this Instruction Manual carefully and keep it handy for future reference.**

Safety Notes



Caution Symbols

Thank you for purchasing this precision crafted Tanita product. For optimum performance and safety, please familiarize yourself with the **Caution Symbols** below. These symbols are designed to alert the user to potential hazards when using this equipment. Ignoring these **Caution Symbols** may result in serious injury, or damage to the product. Please be sure to review before proceeding with the INSTRUCTION MANUAL.

	WARNING This symbol indicates the possibility of serious injury if the product is mishandled or instructions are ignored.
	CAUTION This symbol indicates the possibility of physical injury or equipment damage if instructions are ignored.
	This symbol indicates general precautions that should be taken when using this product.

WARNING Individuals with a Pacemaker or Other Internal Medical Devices
 This equipment sends a weak electrical current through the body during measurement. Individuals who have internally implanted medical devices, such as Pacemakers, should not use this equipment due to the risk of malfunction to the device that may be caused by the weak electrical current.
Inserting and Removing the Power Cord
 To reduce the risk of electric shock or product damage, never insert or remove the power cord with wet hands.
 Do not under any circumstances dismantle or alter the device, as this could result in electric shock or injury as well as adversely affect the precision of measurements.
To prevent fire hazard
 Use only a correctly wired (100-240VAC) outlet, and do not use a multiple outlet extension cable.
Measurements for physically disabled persons
 Physically disabled persons should not attempt to take measurements alone, but instead should have their caretakers assist them in using the device.

CAUTION When connecting the BC-418MA to a computer
 Ensure that the computer conforms to IEC950.
Cross Contamination
 The Body Composition Analyzer should be used with bare feet. Please be sure to clean the scale platform with appropriate disinfectant after each use. **Never pour any liquid directly on the scale platform**, as it may leak and cause internal damage. Use a soft cloth and appropriate ethyl alcohol to wipe off platform. Do not wipe the platform with strong chemicals.
Interpretation of Results
 The data provided by this machine, as well as any supplementary information such as diet or exercise programs based on this data, should be interpreted by a licensed professional. Please make sure you place the Weighing Platform on a level and stable surface. If the equipment is used when the Weighing Platform is unstable because not all feet are on the surface, there may be a risk of stumbling or inaccurate measurement.
 Never jump on the Weighing Platform, there may be a risk of stumbling and malfunction of the equipment.
 When handling printer unit, avoid any sharp edges.
 For the BC-418MA; Ensure you use the original AC adapter (MODEL: SA25-0535U). Using an AC adapter other than the original one may cause malfunction.
 Do not insert or remove the plug by the cable.

Maintenance

Since this equipment is accurately manufactured and adjusted, please observe the following instructions.
 Never disassemble the equipment as this may cause malfunction. Users must not disassemble or adjust this equipment. Please inspect the equipment in accordance with the regulations in your country.
 Unplug the unit from the wall outlet when it will not be in use for long periods of time.
 In order to reduce the risk of a short circuit, please keep any liquid or metal objects (paper clips, etc.) away from the printer. Keep the electrodes clean by wiping them with disinfectant.
 Do not drop the unit, and avoid locations with constant vibration.
 Do not put this equipment in direct sunlight, close to heaters or near direct draughts from air conditioners.
 When transferred to any location where there is a difference of more than 20 degrees centigrade (40 degrees Fahrenheit), wait 2 hours before using.
 When disposing of this unit, please do so in accordance with the prevailing regulations in each country.

General Instructions for Accurate Measurement

This equipment sends out a very weak electric current to measure impedance (electrical resistance) of the body. Therefore, in principle, users need to use this equipment with bare feet. Moreover, since impedance fluctuates in accordance with the distribution of body fluid, please observe the following instructions for accurate measurement.
 To prevent a possible discrepancy in measured values, avoid taking measurements after vigorous exercise until sufficiently rested.
 To prevent inaccurately low body fat percentage measurements and other measurement errors, always hold both arms straight down when taking measurements.
 As changes in body water and body temperature can have a major impact on measurements, measurements should be made every day at the same time under similar conditions (always urinating before taking measurements, etc.) to get a more accurate picture of the measurements over time.
 Ensure that your arms are not touching your side and that the inner thighs are not touching each other during measurements; if necessary, place a dry towel between your arm and side and/or between your thighs.
 Also, make sure the soles of feet are free of excess dirt, as this may also act as a barrier to the mild current. False results may be reported after excessive food /fluid intake, or after periods of intense exercise.
 * For further details, see the Technical Notes on page 36.
 This equipment is designed for the majority of the population leading healthy lives with a regular lifestyle. For people suffering from sickness, or whose lifestyle is very different from the norm, it is recommended that the data from this product should not be used as an absolute value, but rather as a reference to observe the rate change.
 * For further details, see the Technical Notes on page 36.
 If there are calluses on the soles of the feet, or an individual is wearing thin nylons, accurate measurement may still be possible. Place 0.5ml of water in the center of each electrode. This will act as a conductant, and may allow the current to pass freely through a thin barrier.
 Measurement is sometimes impossible on a surface that is strongly vibrating. In this case, please move the equipment onto a surface with little vibration.
 Do not take measurements while using transmitters, such as mobile phones, which may affect readings.

<Usage Conditions>

Temperature Range for Use : 0°C / 35°C
 Relative Humidity : 30% / 80% (without condensation)

<Storage Conditions>

Temperature Range of Environment : -10°C / 50°C
 Range of Relative Humidity : 10% / 90% (without condensation)
 To avoid malfunctions, avoid storing the equipment where there is direct sunlight, significant temperature changes, the risk of dampness, a large amount of dust, in the vicinity of fires, or where there is the risk of receiving vibrations or shocks.

<Power Source>

	Value Range
Model Name	BC-418MA
Voltage Range	100~240VAC
Frequency Range	50/60Hz
Electric Current Range	550mA

1.Product Assembly and Components



Product Structure

Please verify that the following components are in the package.

- ① Paper Dispenser Cover
- ② Printer Cover
- ③ Control Panel
- ④ Digital Display
- ⑤ Left-hand grip
- ⑥ Right-hand grip
- ⑦ Column
- ⑧ Anterior Electrodes
- ⑨ Posterior Electrodes
- ⑩ Level Gauge
- ⑪ Adjustable feet

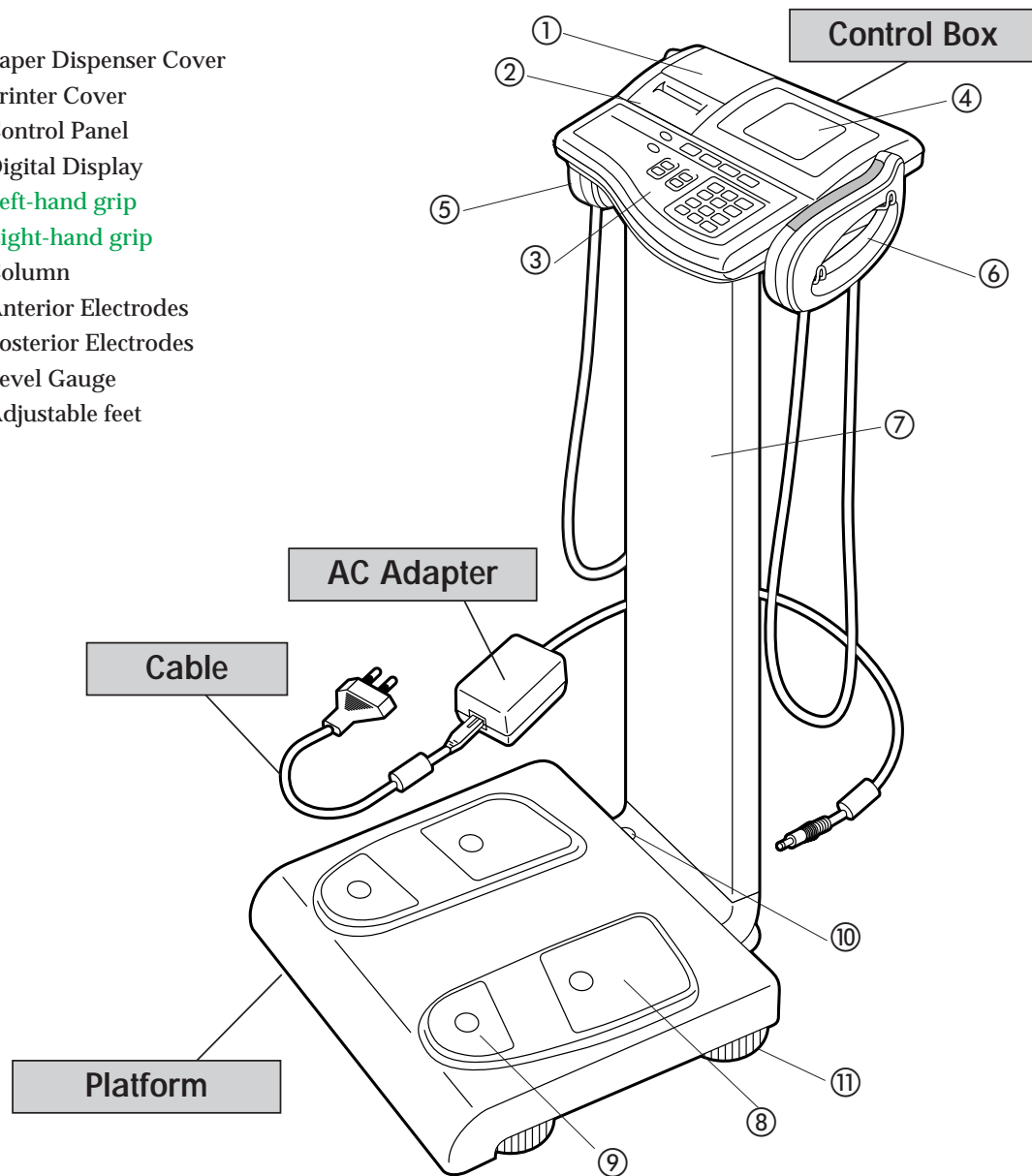

Rear View of Control Box

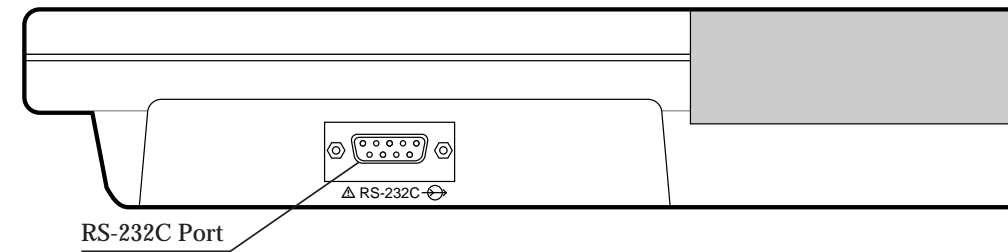

Digital Display

<p>Body weight mark Indicates that the device is being used to measure body weight</p> <p>Clothes weight mark Indicates that the weight of clothes is being subtracted</p> <p>Gender mark (male) Indicates that the user is male</p> <p>Gender mark (female) Indicates that the user is female</p> <p>Athlete mark Indicates that the user is an "athlete"</p> <p>Ready mark Indicates that the device is ready to begin measurements</p>		<p>Measurement unit mark (kg) Indicates that the weight is shown in kilograms</p> <p>Stabilize mark Indicates that the displayed figure has stabilized</p> <p>Unit of height (cm / ft. in) Indicates that the height is shown in either centimeters or in feet and inches</p> <p>Age mark Indicates that the figure shown is the user's age</p> <p>Body fat percentage Indicates that the figure shown is the body fat percentage</p>
---	--	--

Accessories

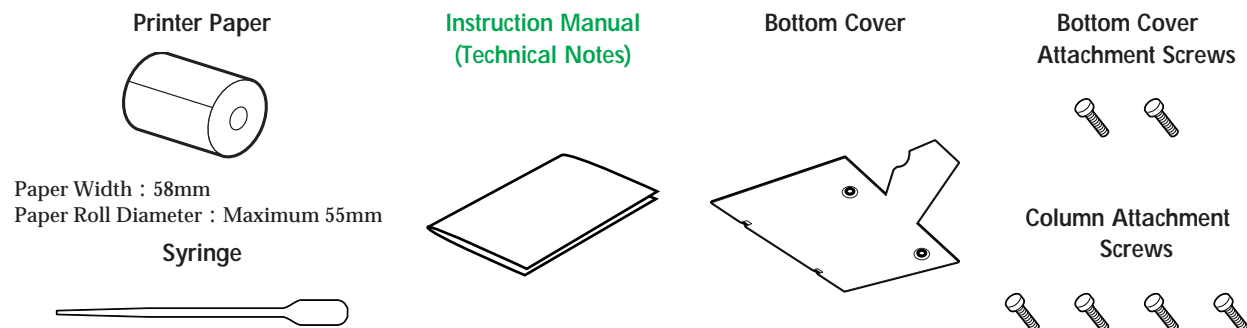

2.Assembly Instructions

GB

Membrane Switch

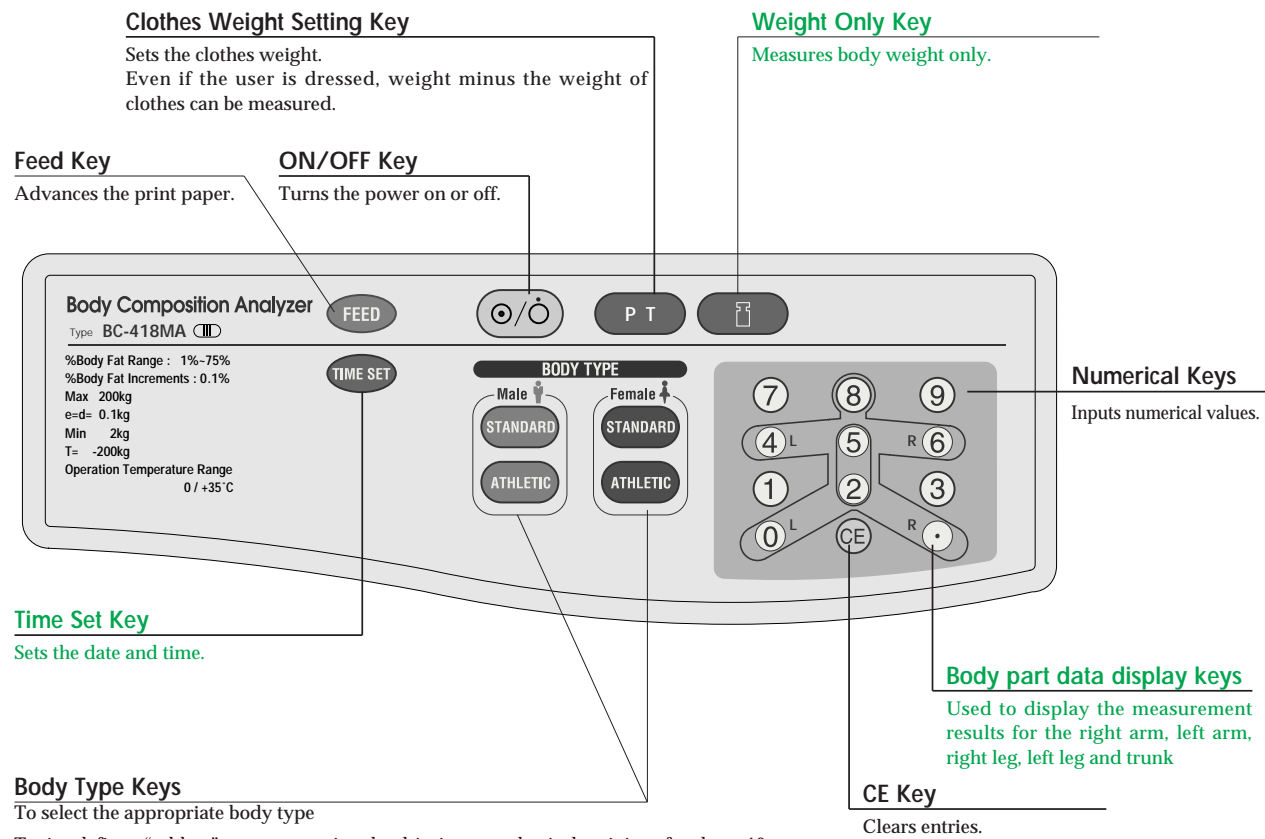

Digital display



GB

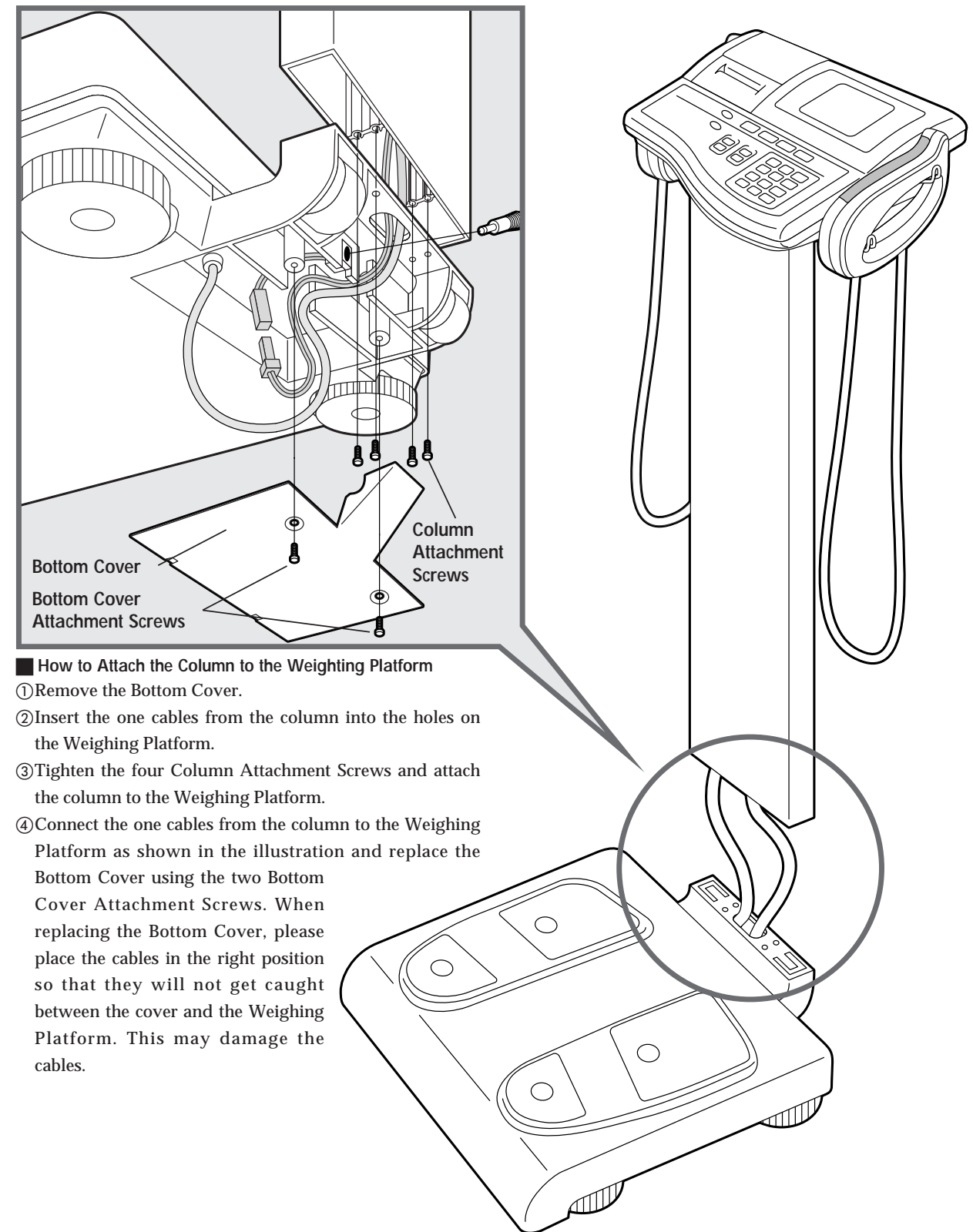

3.Preparation for Use

GB

Connection and Installation

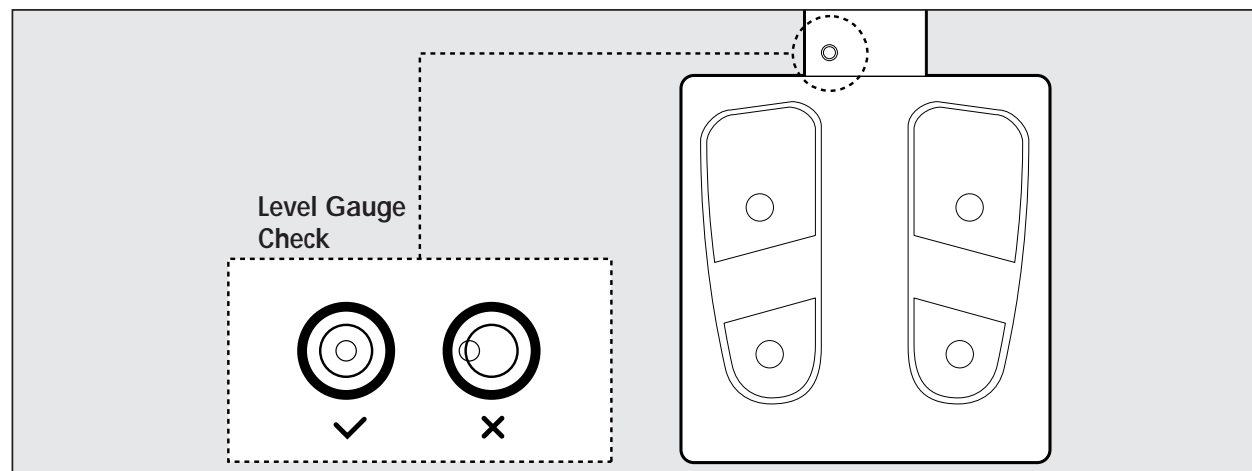

For accurate measurement, place the Weighing Platform on as flat a surface as possible and adjust the level with the adjustable feet so the bubble in the level gauge is in the center of the frame.

CAUTION

Make sure you place the Weighing Platform on a stable level surface and adjust the level with the adjustable feet. If the Weighing Platform is not stable because not all the feet are on the surface, for example, there is a risk of stumbling or inaccurate measurement.

Connection of Plugs

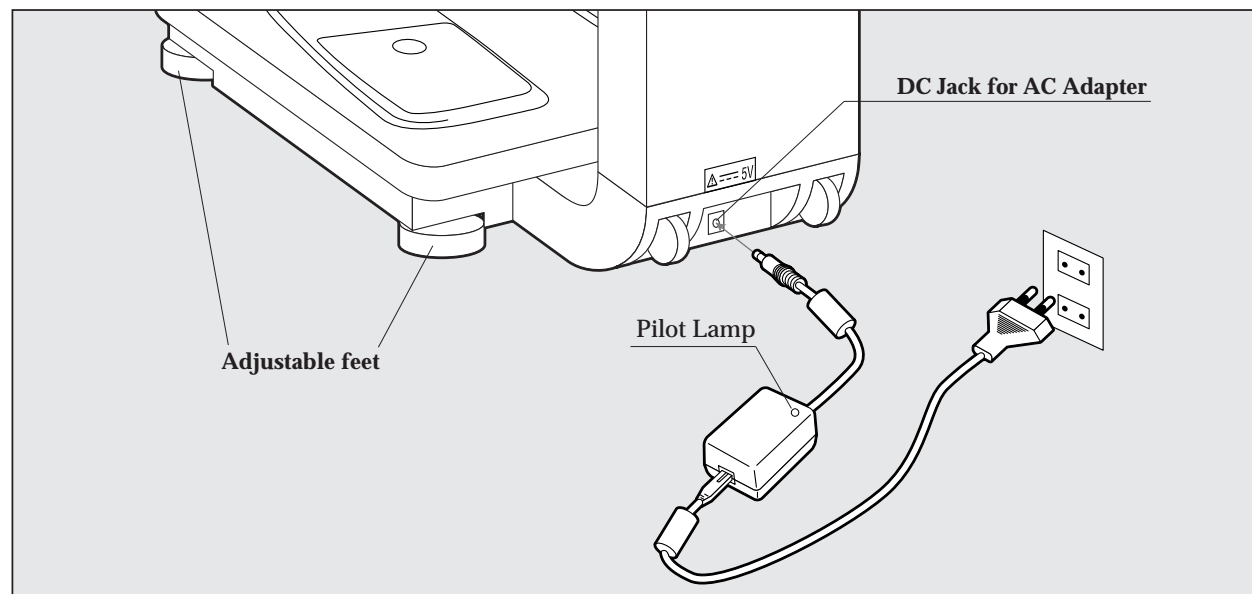

1. Insert the plug from the AC adapter into the DC jack on the back of the Control Box.
2. Connect the cable and the AC adapter and insert the plug on the cable into the wall outlet.

WARNING

CAUTION

- To avoid electric shock, do not insert or remove the plug with wet hands.
- To avoid electric shock, do not use the equipment near water.
- To avoid measurement error, do not measure while using equipment that generates radio waves, such as mobile phones.

Loading the Printer Paper Roll

GB

CAUTION

Please change the paper roll when red lines appear along the sides of the paper.

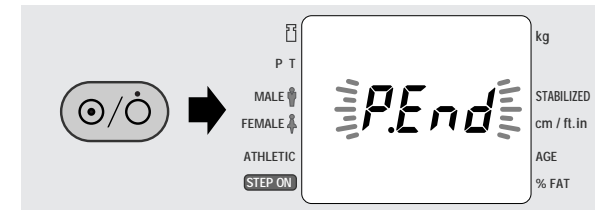

1. Turn the equipment on by pressing the [P/End] key. "P.End" will flash in the middle of the screen. This means that there is no printer paper. * When you do not have any printer paper to replace the old roll, press the [CE] key. "P.End" will disappear and you can continue measurement.

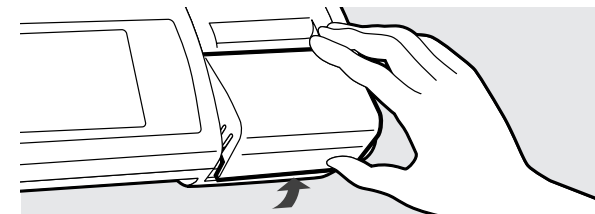

2. Remove the Paper Dispenser Cover. When you lift up the Paper Dispenser Cover from the back of the Control Box, it can be easily removed.

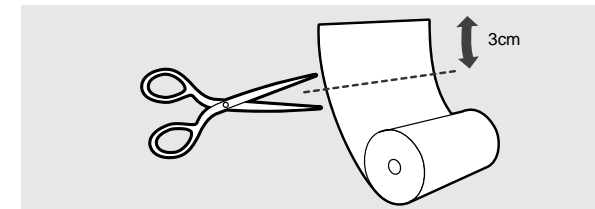

3. Cut off the end of the printer paper where the glue is (about 3 cm) in a straight line.
 CAUTION Please make sure to cut off the part with the glue because the glue may hinder the paper feeding through the printer.

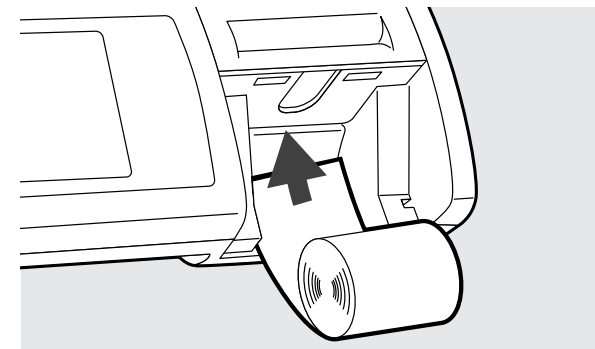

4. Insert the printer paper into the slit. The printer paper is automatically rolled up and the edge of the paper is cut automatically. Please remove the cut paper.
 CAUTION Please make sure you insert the printer paper straight into the slit.

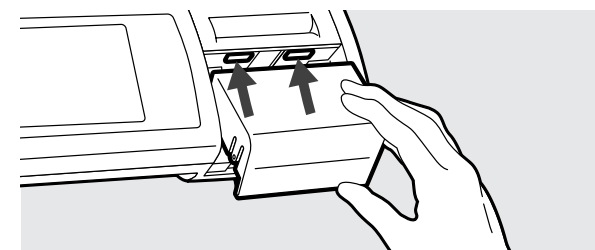

5. Insert the catches of the Paper Dispenser Cover into the guide holes.
 * If a paper jam occurs, please refer to P. 25.

4. Setting Date and Time

Setting the date and time

 The printer function is ON in the display shown below.

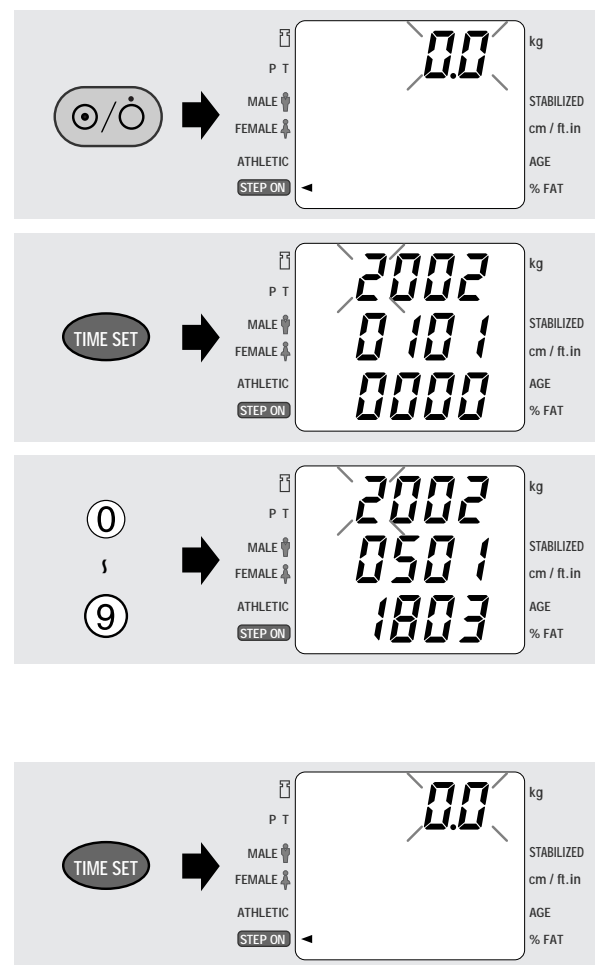

- 1. Push the [ON/OFF] key.**
 The entire display will begin to flash, and then the clothes weight input screen will appear.
- 2. Push the [TIME SET] key.**
 The date and time input screen will appear.
 The upper row of numbers show the year, the middle row the month and day, and the bottom row the time (hours and minutes).
 * If no changes are to be made, press the [TIME SET] key again.
- 3. Input the present date and time.**
 Input the appropriate numbers, beginning with the top row, in the flashing space.
 Example: To input May 1, 2001, 6:03 p.m., press in order the following keys:
 [2][0][0][2][0][5][0][1][1][8][0][3]
 * If you make an error while inputting a number, press the [CE] key.
 This will return you to the previous input space.
- 4. Press the [TIME SET] key.**
 The date and time are set, and the clock function is running.
 The display will now return to the step prior to entering this mode.
 * The clock function is backed up by the rechargeable battery, but natural electric discharge of the rechargeable battery may occur if the device is not in use for an extended period (more than 2 weeks); this will clear the settings, making it necessary to reset the date and time.

5. Mode Selection

Set the functions (modes) that you want this equipment to start with. The selected modes will be automatically recorded. If it is not necessary to change the settings, the equipment will start up when you simply press the [ON/OFF] key.

Setting the number of printouts, the printout language, and the printout items

Select the number of print outs (0 - 9) and language. (English, French, German, Italian, Spanish)

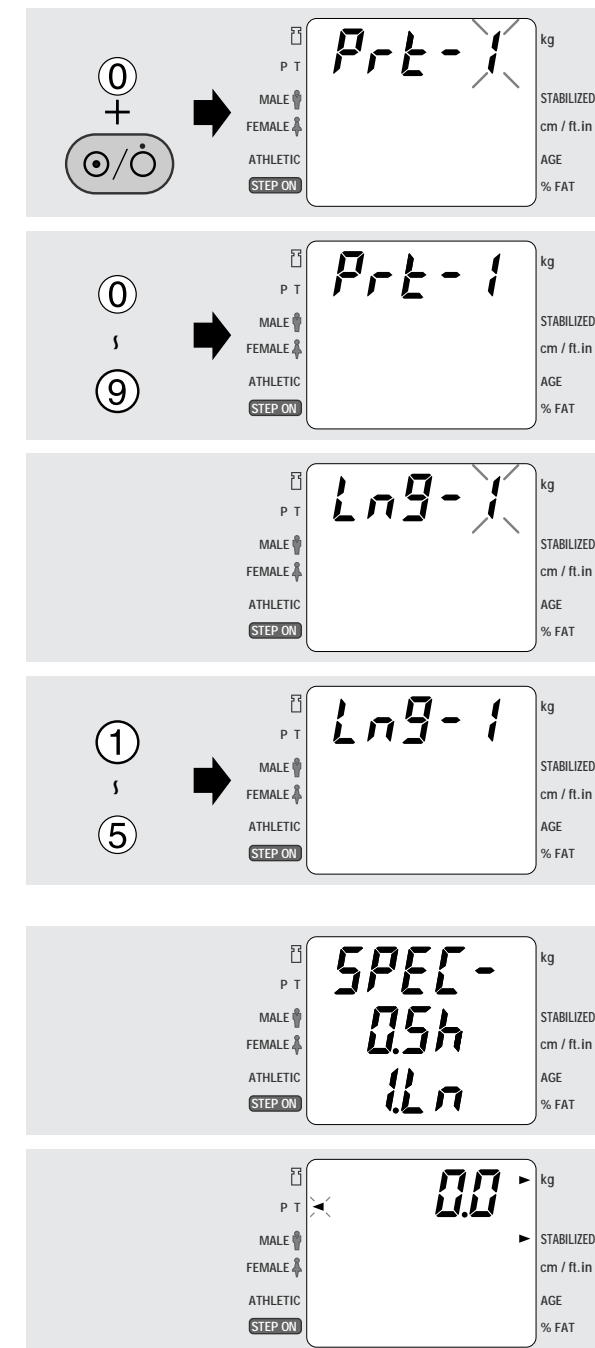

- 1. While holding down the [0] key, press the [ON/OFF] key.**
 Release the keys after "Prt-1" is displayed on the screen.
- 2. Select the number of print outs**
 Using the numerical keys, enter the quantity of print outs desired.
 The maximum number is nine.
 [1]-[9] : Quantity of print outs
 [0] : No printout
- 3. Language Selection**
 If "0" is selected at step 2, you cannot preset the language.
 The display will automatically change to the language selection screen. The currently selected language will be displayed as a number.
 Example: (LNG-1) means English.
 Select the language desired using the numerical keys.
 [1] : English
 [2] : French
 [3] : German
 [4] : Italian
 [5] : Spanish
- 4. Printing selection**
 Printing contents are selected from numerical keys.
 [0] : Short
 [1] : Long
- 5. The display will automatically change to the measurement screen after all the input has been completed.**
 If further change to the print settings is desired, please turn off the equipment and follow steps 1 - 4 above.

 The equipment will start up with these settings next time you use it.

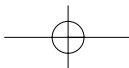

Setting the Original Mode

This process is utilized to select whether or not you use the target body fat ratio function. (See the printout sample on page 16.)



< HINT! >

The target body fat ratio function is deactivated when this product is shipped from factory.

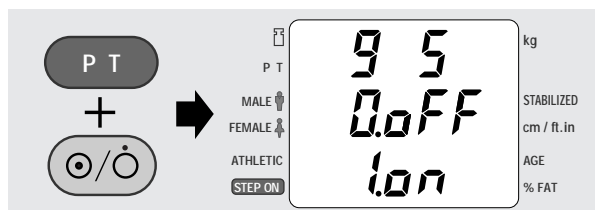

1. Press the **P T** key while holding down the **0/0** key.

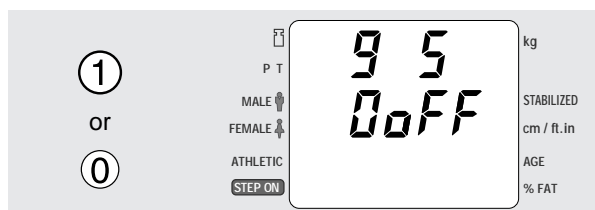

[0] : The target body fat ratio function is deactivated
 [1] : The target body fat ratio function is activated
 ⚠ If the number of print outs is set to "0" during the process of "Setting the Number of Print Outs and Language" on page 13, you cannot preset this item.

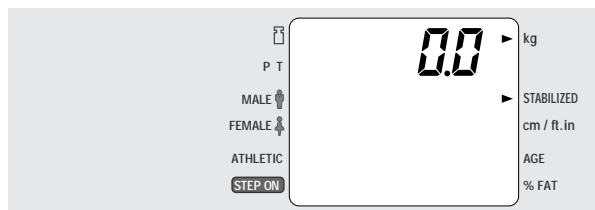

2. After the input is completed, the display will automatically change to the measurement screen.

⚠ The equipment will start up with these settings next time you use it.

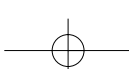



Sample

This section prints the both the body type and body composition data of the current user.

1

TANITA
 BODY COMPOSITION
 ANALYZER
 BC-418
 21/SEP/2002 19:29
 BODY TYPE STANDARD
 GENDER MALE
 AGE 34
 HEIGHT 179 cm
 WEIGHT 73.3 kg
 BMI 23.9
 BMR 7294 kJ
 1743 kcal
 FAT% 13.1 %
 FAT MASS 9.6 kg
 FFM 63.7 kg
 TBW 46.6 kg
 DESIRABLE RANGE
 FAT% 8-20 %
 FAT MASS 5.5-15.9 kg

TARGET BF% is : 20%
 Predicted weight : 79.6 kg
 Predicted fat mass : 15.9 kg
 FAT TO GAIN: 6.3 kg

Consult your physician before beginning any weight management program. Tanita is not responsible for determining your target BF%.

IMPEDANCE
 Whole Body 551 Ω
 Right Leg 212 Ω
 Left Leg 214 Ω
 Right Arm 292 Ω
 Left Arm 309 Ω

Segmental Analysis
 Right Leg
 Fat% 8.9 %
 Fat Mass 1.1 kg
 FFM 11.5 kg
 Predicted MuscleMass 10.9 kg

Left Leg
 Fat% 10.1 %
 Fat Mass 1.2 kg
 FFM 11.0 kg
 Predicted MuscleMass 10.4 kg

Right Arm
 Fat% 14.0 %
 Fat Mass 0.6 kg
 FFM 3.6 kg
 Predicted MuscleMass 3.4 kg

Left Arm
 Fat% 15.4 %
 Fat Mass 0.6 kg
 FFM 3.5 kg
 Predicted MuscleMass 3.3 kg

Trunk
 Fat% 15.0 %
 Fat Mass 6.0 kg
 FFM 34.1 kg
 Predicted MuscleMass 32.8 kg

2

This section calculates the amount of fat that should be lost or gained to achieve the Target BF% (preset by the user and health care professional).

3

The measurement data for each body part - the predicted muscle mass, the fat mass, and the body fat percentage - are printed out in this portion.

<Printing selection and Goal Setter Mode>

Printing selection	Goal Setter Mode	Input	Print Out
Short [0]	ON [1]	STANDARD	1 2
		ATHLETIC	1 2
		TARGET BF 00%	1
Long [1]	OFF [0]	STANDARD	1
		ATHLETIC	1
		TARGET BF 00%	1 3
Short [0]	ON [1]	STANDARD	1 2 3
		ATHLETIC	1 2 3
		TARGET BF 00%	1 3
Long [1]	OFF [0]	STANDARD	1 3
		ATHLETIC	1 3

For this Printing Selection, please refer to the page 13.
 For this Goal Setter Mode, please refer to the page 14.

6. Operating Instructions

GB

Body Composition Analysis



This explains the procedure when the printer function is turned on. Please be aware that the display may be different if the number of printouts is set to [0].



- Do not wipe the equipment with corrosive chemicals (gasoline, cleaner, etc.). Please use a neutral detergent to clean the equipment.
- When the equipment has been transferred to any location where there is a temperature difference of 20°C or more, wait for at least two hours before using it.
- In taking measurements, please keep the person away from the unit, who uses transmitters such as a mobile phone avoid causing margin errors.

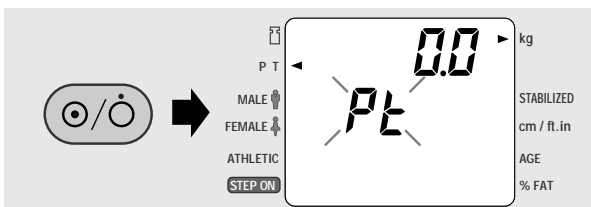

1. Turn on the Power.

Press the [] key.
"0.0" will appear on the upper portion of the display.

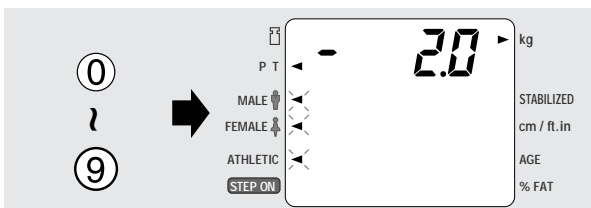

2. Enter Clothes Weight.

Enter clothes weight using the numerical keys.
Example: if the clothes weight is 2.0 kg, press [2], [.] and then [0].
When the data input is completed, the data will be displayed as a minus number.

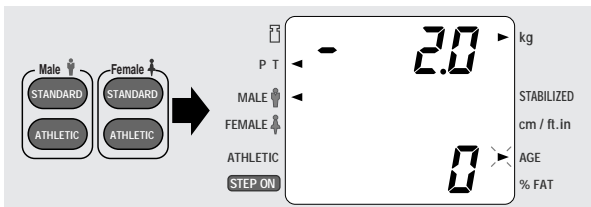

3. Select the Body Type.

Select the Body Type from Standard Male, Standard Female, Athletic Male and Athletic Female. Please use the Athletic key when the user is 17 years or older and also meets the following criteria.
[See page 8 for Tanita's definition of "Athlete."](#)

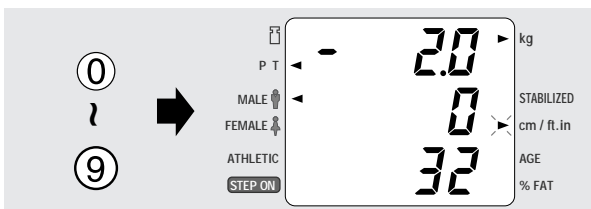

4. Enter Age.

- If the user is 32 years old or younger.
Example: Press [3] and [2].
- If the user is 9 years old or younger
Example: press [0] and [9].
- If ages 16 or less are entered, even if Athletic is selected for the Body Type, it will be automatically changed to Standard.

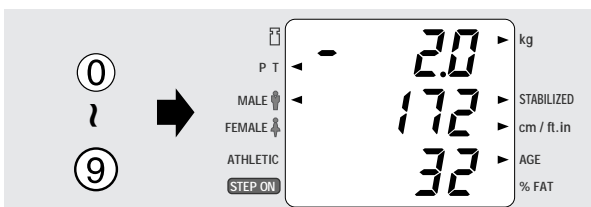

5. Enter Height.

Example: If the user's height is 172 cm, please press [1], [7] and then [2].

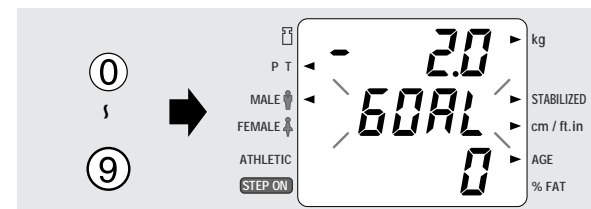

6. Set the Target Body Fat Ratio.

After you input the height, "GOAL" will automatically flash on the display. Input the target body fat ratio desired using the numerical keys.

Example: 16% = Press [1] and [6].
9% = Press [0] and [9].

- If the number of print outs is set to "0", nothing will be displayed.
- If the target body fat ratio is set to OFF, the target body fat ratio will not be printed out.



- Before you start a body weight management program and set the appropriate personal body fat ratio, please consult your doctor. Tanita is not responsible for setting the appropriate target body fat ratio for specific individuals.

- For details of the desirable body fat percentage, please refer to the Technical Notes. Male athletes may wish to select a single digit body fat percentage as their target. However, this is not recommended for Standard Adults, in particular women, who should avoid becoming excessively lean. Always consult a doctor about the target body fat percentage most suitable for your body type.



- Do not step on the Weighing Platform until the target body fat ratio setting has been completed because the power may be automatically turned off or the measurement may be inaccurate.

- If you want to change the settings, please press the [] key and the procedure will go back to the former step. Please re-enter the data.

7. After "88888" is displayed on the upper portion of the display, a flashing arrow will appear next to .

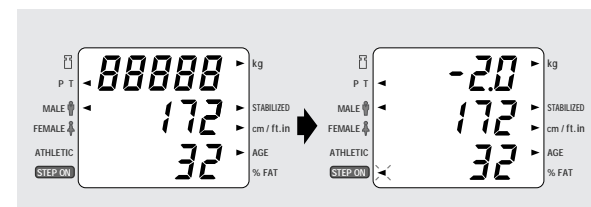

8. Start Measurement.

Step on the Weighing Platform with bare feet so they touch the electrodes. Stand in a stable position without bending your knees.



Do not use the hand grips, as you will only be measuring your body weight this time.

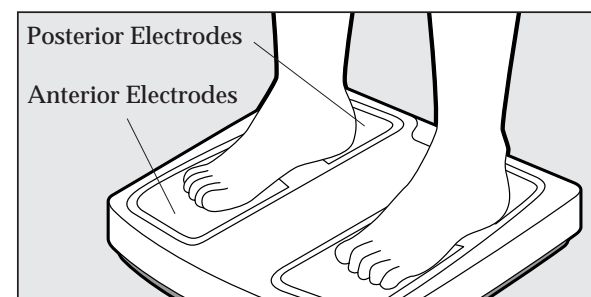

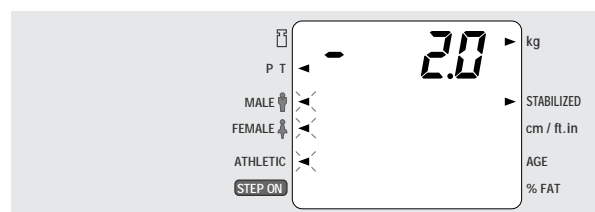
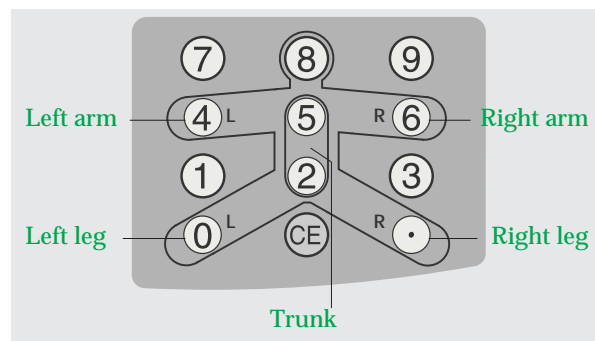
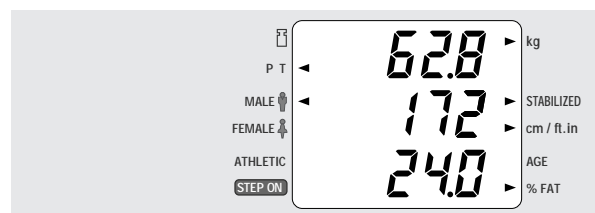
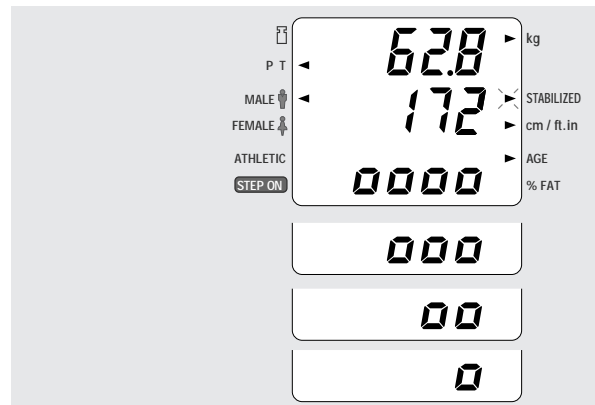

9. Taking Measurement.

Step on the weighing platform in bare feet. Make sure heels are placed on the posterior electrodes, and the front part of the feet are in contact with the anterior electrodes.

10. Measure the Impedance.

When the grips are grasped with both hands, 0000 will appear at the bottom of the display and the impedance measurement will begin.

The 0000 marks will disappear one by one during the measurement; after five full cycles, the measurement will be complete.



Grab the grips (two locations) only after the body weight figure on the display has stabilized.

Do not step off the Weighing Platform until the "0000" symbols disappear completely.

In cases when measurements of the body fat ratio or the quantity of fat are abnormally small or the error message (E01) is shown on the display, the probable reason is that the soles of the feet and the electrodes are not in full contact. Make sure you step on the Weighing Platform so there is contact between the electrodes and the soles of your feet. If the problem is not solved this way, it is possible that the soles of the feet have calluses and the resistance is too great. Therefore, place about 0.5 ml of water on each of the four electrodes where the feet touch before measurement.

11. Measurement Is Completed.

Once the body weight and impedance measurements have been completed, the overall body fat percentage will be shown at the bottom of the display and a buzzer will sound.

If the printer is ON, the measurement results will be printed out.

* With regard to the measurement result, please refer to P. 22.

If the printer is OFF, the measurement results (predicted muscle mass, fat mass, and body fat percentage) for each body part can be displayed using the ten-key pad.

Select the number of the desired body part on the ten-key pad.

[4]: Left arm

[6]: Right ar

[0]: Left leg

[.]: Right leg

[5] and [2]: Trunk

* See page 13 for details on printer settings.

Step off the Weighing Platform.

12. When You Continue to Measure.

After printing is completed, go back to step 3. Measure by entering the data in the same procedure.

13. Finish Measurement.

Press the [ON/OFF] key and turn off the power.

Weight Only Function

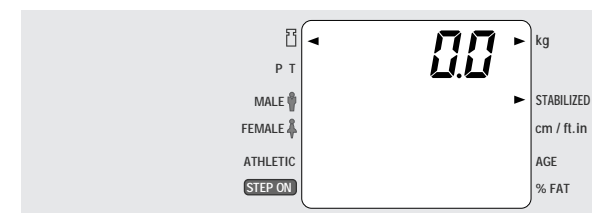
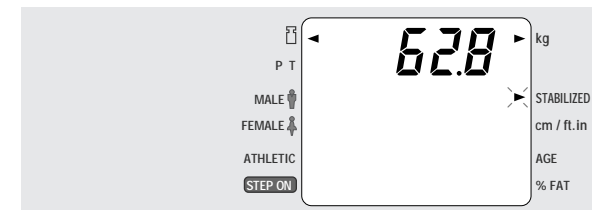
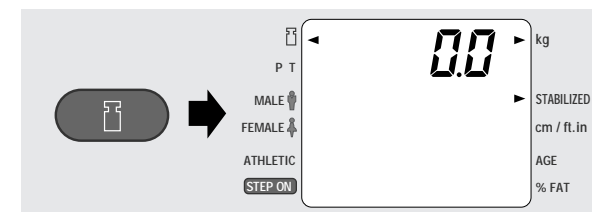

1. After turning on the unit, press the [ON/OFF] key. After a momentary display check, "0.0" will appear on the LCD. If measuring units need to be changed, do so at this time by pressing the [UNIT] key. An arrow on the LCD will follow the selection of weighing units.

2. Weight Measurement. Step on the weighing platform. Weight will be displayed on the LCD.

3. When measuring is complete, press the [ON/OFF] key to turn off the power.



No printer is available when measuring weight only.

If body composition analysis is desired, turn the unit off and then on, using the [ON/OFF] key.

Important Note: There is no automatic weight lock function.

Setting of Clothes Weight

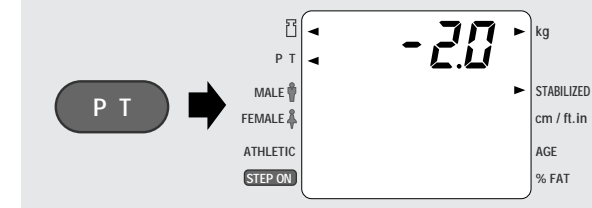
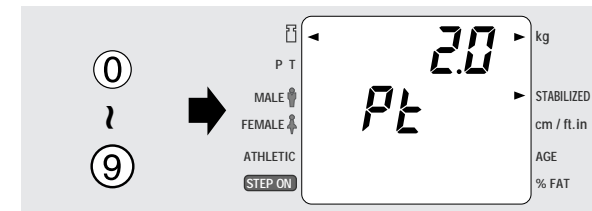
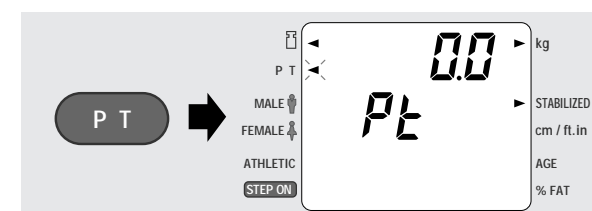

1. Press the [P T] key. The arrow next to P T will flash.

2. Enter the clothes weight. Example: If the clothes weight is 2.0 kg, press [2], [.] and then [0]. * When you want to correct an entry, press the [CE] key and enter the data again.

3. Finalizing the setting Press the [P T] key to finalize the clothes weight. The finalized clothes weight is displayed with a minus, an arrow next to P T lights up, and it becomes possible to measure your weight.

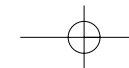

Explanation of the Print Out

BMI:Body Mass Index is a height to weight ratio, and is calculated by the following formula:

$$\frac{\text{Weight (kg)}}{\text{Height (m)}^2}$$
 Desirable Range 18.5 - 24.9

FAT%:The percentage of total body weight that is fat.

FFM:Fat Free Mass is comprised of muscle, bone, tissue, water, and all other fat free mass in the body.

PW:Predicted weight
 Calculated weight for the given Target BF%.

FAT TO LOSE/GAIN:
 Calculated fat mass to lose or gain to achieve the Predicted Weight.

IMPEDANCE:Impedance reflects the body's inherent resistance to an electrical current. Muscle acts as a conductor of the electrical current, adipose tissue acts as a resistor.

Sample

TANITA
 BODY COMPOSITION
 ANALYZER
 BC-418

21/SEP/2002 19:29

BODY TYPE STANDARD
 GENDER MALE
 AGE 34
 HEIGHT 179 cm
 WEIGHT 73.3 kg
 BMI 23.9
 BMR 7294 kJ
 1743 kcal
 FAT% 13.1 %
 FAT MASS 9.6 kg
 FFM 63.7 kg
 TBW 46.6 kg
 DESIRABLE RANGE
 FAT% 8-20 %
 FAT MASS 5.5-15.9 kg

TARGET BF% is : 20%

Predicted weight : 79.6 kg

Predicted fat mass : 15.9 kg

FAT TO GAIN: 6.3 kg

Consult your physician before beginning any weight management program. Tanita is not responsible for determining your target BF%.

IMPEDANCE

Whole Body	551 Ω
Right Leg	212 Ω
Left Leg	214 Ω
Right Arm	292 Ω
Left Arm	309 Ω

BMR:Basal Metabolic Rate represents the total energy expended by the body to maintain normal functions at rest such as respiration and circulation.

FAT MASS:Total weight of fat mass (in kg, lb) in the body.

TBW:Total Body Water is the amount of water (expressed as lb, kg, or st.lb) retained in the body. TBW is said to comprise between 50% - 70% of total body weight. Generally, men tend to have higher water weight than women due to a greater amount of muscle.

PFM:Predicted fat mass
 Calculated fat mass for the given Target BF%.

Segmental Analysis

Right Leg	Fat%	8.9 %
	Fat Mass	1.1 kg
	FFM	11.5 kg
	Predicted MuscleMass	10.9 kg
Left Leg	Fat%	10.1 %
	Fat Mass	1.2 kg
	FFM	11.0 kg
	Predicted MuscleMass	10.4 kg
Right Arm	Fat%	14.0 %
	Fat Mass	0.6 kg
	FFM	3.6 kg
	Predicted MuscleMass	3.4 kg
Left Arm	Fat%	15.4 %
	Fat Mass	0.6 kg
	FFM	3.5 kg
	Predicted MuscleMass	3.3 kg
Trunk	Fat%	15.0 %
	Fat Mass	6.0 kg
	FFM	34.1 kg
	Predicted MuscleMass	32.8 kg

PMS:Predicted Muscle Mass means bone-free lean tissue mass (LTM)



Body Fat Ranges for Standard Adults

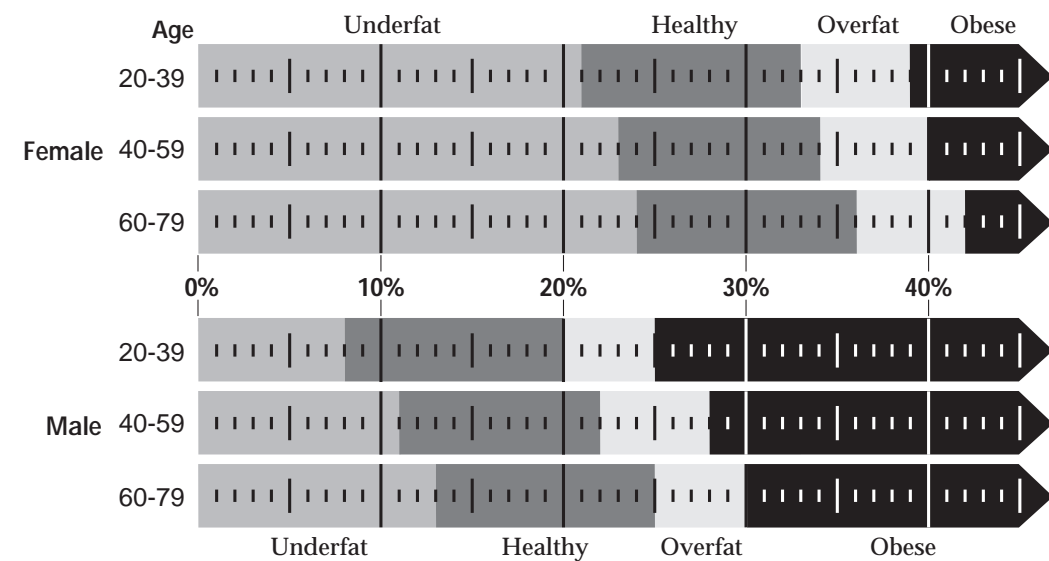

* As reported by Gallagher, et al., at NY Obesity Research Center.
 To determine the percentage of body fat that's appropriate for your body, consult your physician.

Based on NIH/WHO BMI Guidelines

Underweight	BMI < 18.5
Normal Range	18.5 BMI < 25
Pre obese	25 BMI < 30
Obese	CLASS I 30 BMI < 35
Obese	CLASS II 35 BMI < 40
Obese	CLASS III BMI 40

NOTE:Please refer to the Technical Notes for details.



Please consult your doctor before you start a body weight management program. Tanita is not responsible for the target body fat ratio.

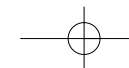

7. Clearing Paper Jams

GB

Components of the Printer Unit

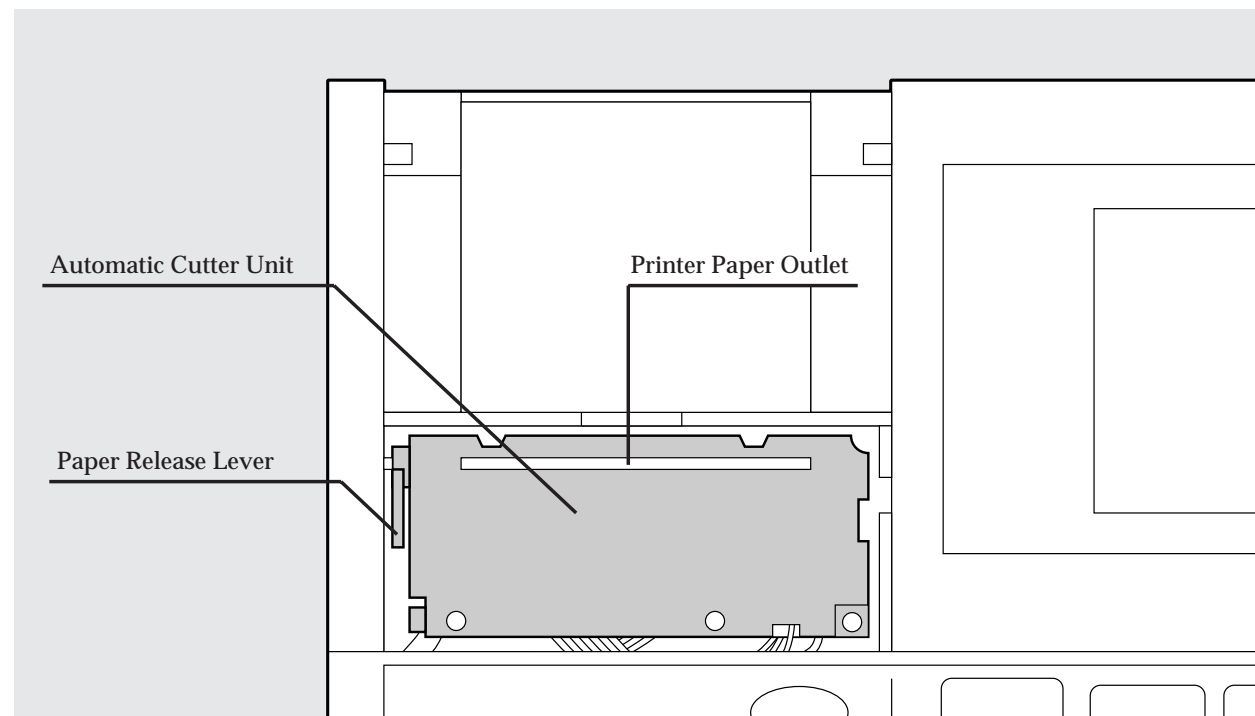

* This is a picture of the Control Box without the Printer Dispenser Cover and the Printer Cover, looking down from above.

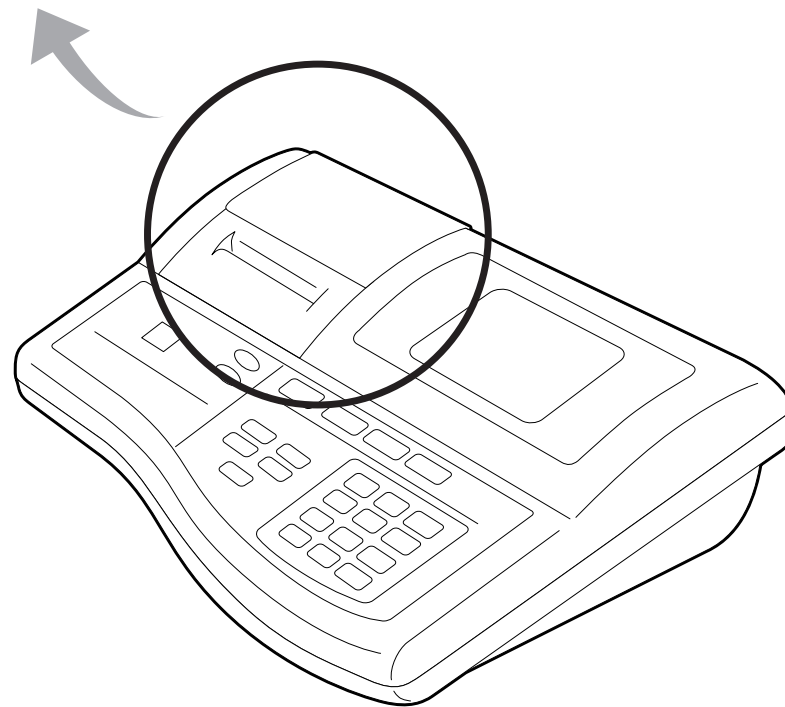

Clearing Paper Jams

GB

CAUTION

Please pay careful attention to avoid injury from the sharp edge.
Please turn off the machine before clearing Paper jams.

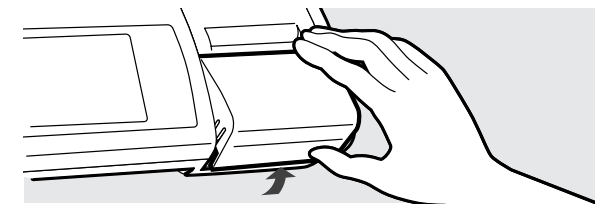

1. **Remove the Paper Dispenser Cover.**
If you lift up the Paper Dispenser Cover from the back of the Control Box, it can be easily removed.

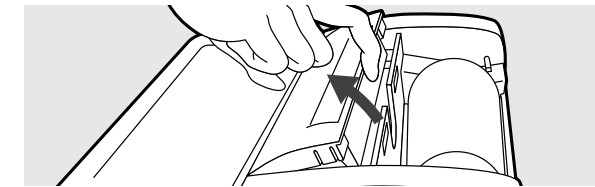

2. **Remove the Printer Cover.**
As shown in the illustration, from the front side of the Control Box, use a finger to lift up the Printer Cover.
 **The Printer Cover is firmly fixed by catches. Please make sure not to drop the Control Box when you remove the Printer Cover.**

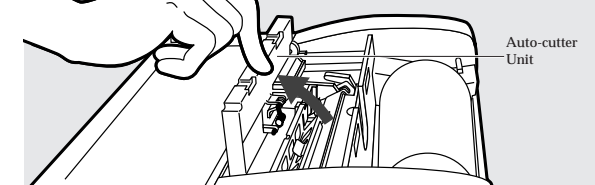

3. **Lift up the Automatic Cutter Unit.**
From the front side of the Control Box, lift up the Automatic Cutter Unit with a finger.

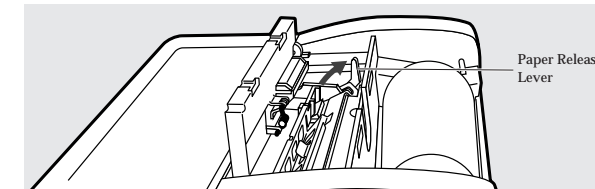

4. **Raise the Paper Release Lever and remove the jammed paper.**
Remove the printer roll paper and the jammed paper.

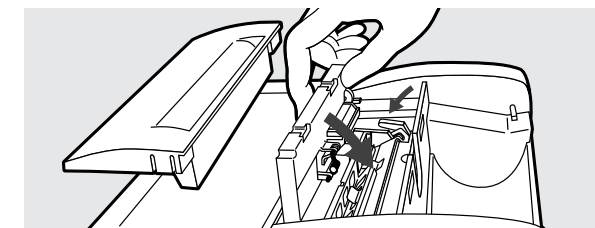

5. **Return the Paper Release Lever, the Automatic Cutter Unit and the Printer Cover to the normal position.**
Insert the catches of the Printer Cover into the guide holes of the Control Box and push it down slowly while pressing the catches on both the left and right hand sides until a click is heard.

 **Failure to press down the Paper Release Lever will result in continuous feeding of the printer paper without it being cut automatically.**

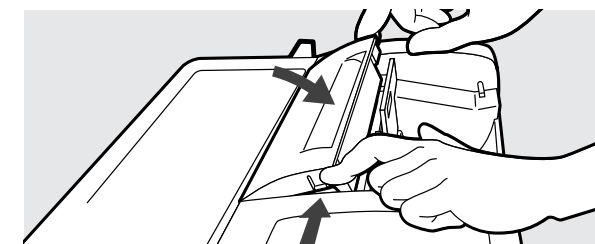

6. **Return the printer paper roll.**
Return the printer paper roll by following the procedure in P. 11 [Loading Printer Paper Roll].

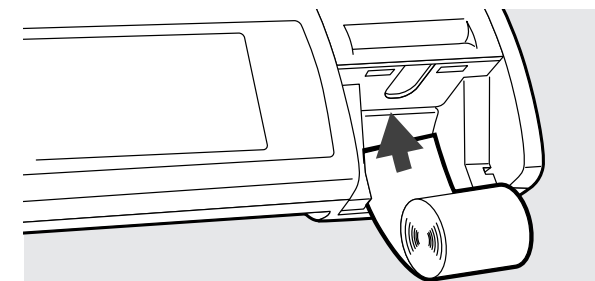

7. **Return the Printer Dispenser Cover to the proper position.**
Press the Printer Dispenser Cover down slowly as the catches of the cover go into the guide holes. P. 11.

8. Troubleshooting



Problem List

If problems occur, please refer to the following instructions before you ask for repairs.

Problem	Solution
Nothing appears on the display after pushing [] key	<ul style="list-style-type: none"> Please confirm that the Control Box is properly connected to the AC Adapter and the AC Adapter is properly connected to the cable.
E-01 is displayed.	<ul style="list-style-type: none"> E-01 is displayed when the impedance shows an abnormal value compared to height and weight. Please make sure that measurement was carried out with bare feet, the electrodes or the soles of the feet were clean, and the feet were correctly in contact with the electrodes. If the feet are dry or have calluses, place water on the electrodes before stepping on the unit. It is possible that the body fat ratio exceeds the measuring capacity. Please stop measuring.
E-02 is displayed and the reading of the trunk cannot be obtained.	<ul style="list-style-type: none"> This sign is displayed when the body fat percentage of the trunk is too low and is off the measurable range. Please refer to the readings of other parts for the body fat.
E-11 is displayed.	<ul style="list-style-type: none"> E - 11 is displayed when there is a loose connection between the control box and the weighing platform. Confirm that none of connections between the scale and control box are loose or unplugged. There may be excessive vibration which will disturb the measurement process.
E-12, 13 or 14 is displayed.	<ul style="list-style-type: none"> The equipment requires readjustment.
E-16 is displayed.	<ul style="list-style-type: none"> Measurement is not possible because impedance is unstable. In order to improve electrical conductivity, please clean the soles of the feet or place water on the electrodes before using the equipment.
No print out	<ul style="list-style-type: none"> Please confirm the number of print outs selected is more than 0. (See P. 13) Please confirm that the correct brand of paper is used. Please confirm that the printer paper roll is placed in the correct position. Please confirm that the printer paper is not jammed.
The printer paper does not come out.	<ul style="list-style-type: none"> Please confirm the printer paper is not jammed.
P.End is displayed and the equipment is incapable of taking a measurement.	<ul style="list-style-type: none"> The printer paper is used up. Please put in a new printer paper roll. (See P.11) Please confirm that the printer paper is being advanced properly. Please make sure that the Paper Release Lever is not in the "Up" position. (See P. 25)
---- is displayed.	<ul style="list-style-type: none"> It is possible that the maximum weight capacity has been exceeded. Please stop measuring.
uuu is displayed. The power has turned off during measurement.	<ul style="list-style-type: none"> Do not stand on or put things on the Weighing Platform before starting measurement. Start measurement after confirming there is nothing on the Weighing Platform.
Feed Key is not functioning.	<ul style="list-style-type: none"> It is possible that the number of print outs selected is 0 or the Weight Scale Mode has been selected. Please select the Body Fat Measurement Mode and select a number larger than 0 for the number of print outs.

RS-232C Interface Instructions

This section describes the interface for outputting the BC-418 Body Composition Analyzer measurement results as RS-232C signals to personal computers and other external devices.

CAUTION Only connect IEC950-compliant computers to the BC-418.

Specifications

Communication Standard	EIA RS-232C Compatible
Communication Method	Asynchronous Transmission
Signal speed	4800 baud
Data bit length	8 bits
Parity	None
Stop bit	1 bit
Terminator	CR+LF

Signal lines and connection methods

Terminal number	Signal name
1	F.G.
2	RXD
3	TXD
5	GND

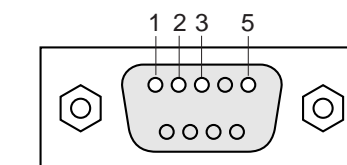

Connection example Always use a reverse cable when connecting to an external computer.

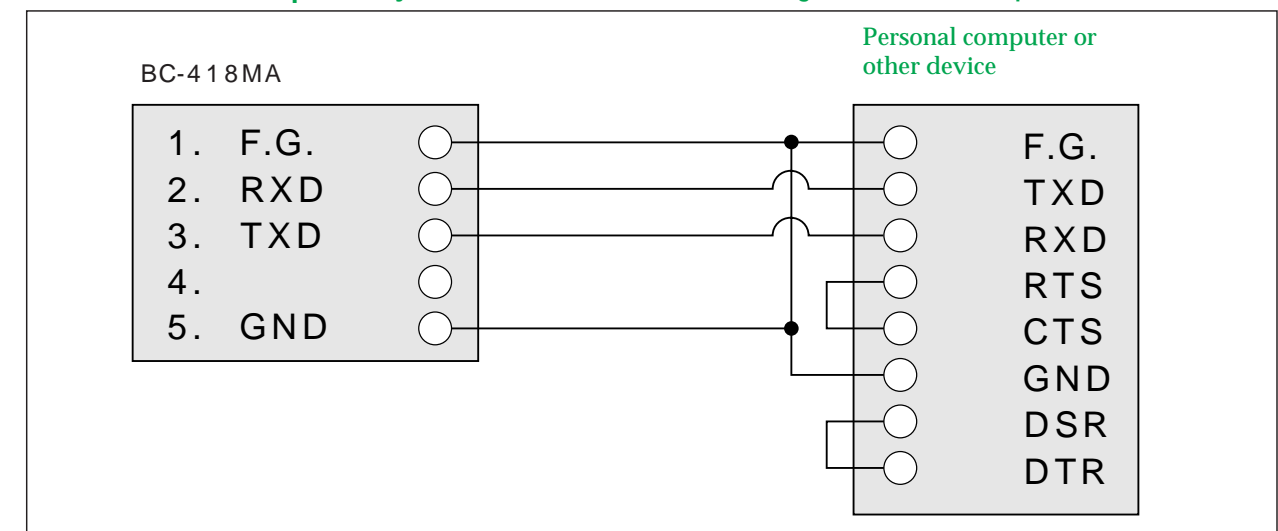

An RS-232C connector (D sub 9-pin male) is located in the lower center on the back of the control box. Use an RS-232C cross cable when connecting to a personal computer or other device.

RS-232C connector (D sub 9-pin male)

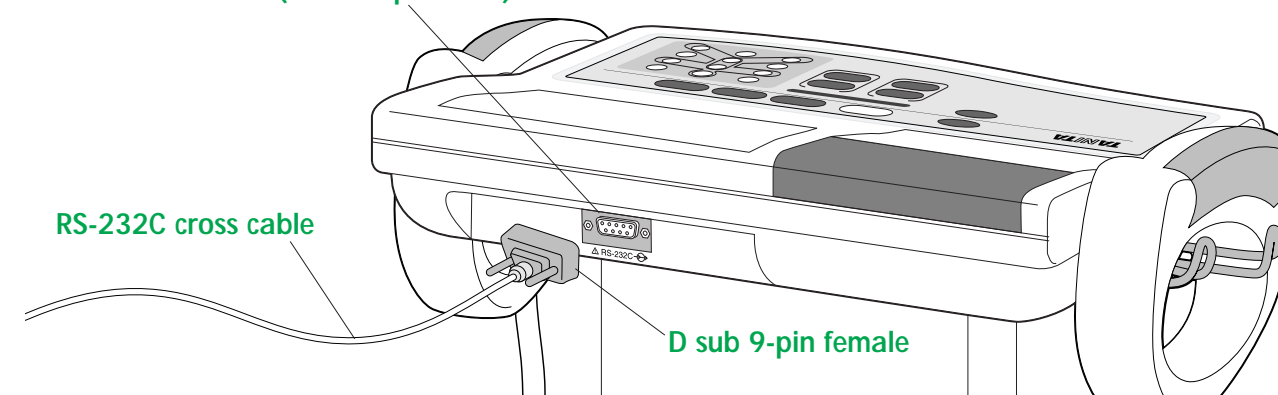

Transmission data



Transmission data will be output after measurements regardless of the status of the personal computer or other device at the receiving end. For that reason, the personal computer or other device to which data will be transmitted must be put in a reception-ready status before measurement.

(1) Output data items

		Output data (ASCII code)		Byte Length
		kg mode	lb mode	
Date		"dd/mm/yy" (date/month/year)	"dd/mm/yy" (date/month/year)	10
Time		"hh:mm" (hour:minutes)	"hh:mm" (hour:minutes)	7
Body type		0: standard 2: athlete	0: standard 2: athlete	1
Gender		1: male 2: female	1: male 2: female	1
Height		xxxx (cm)	xxx.x (inch)	5
Weight		xxx.x (kg)	xxx.x (lb)	5
Body fat percentage		xx.x (%)	xx.x (%)	4
Fat mass		xxx.x (kg)	xxx.x (lb)	5
Fat free mass		xxx.x (kg)	xxx.x (lb)	5
Body water mass		xxx.x (kg)	xxx.x (lb)	5
Age		xx	xx	2
BMI		xxx.x	xxx.x	5
BMR		xxxxx (kJ)	xxxxx (kJ)	5
Impedance	Whole body	xxx ()	xxx ()	3
	Right leg	xxx ()	xxx ()	3
	Left leg	xxx ()	xxx ()	3
	Right arm	xxx ()	xxx ()	3
Right leg	Left arm	xxx ()	xxx ()	3
	Body fat percentage	xx.x (%)	xx.x (%)	4
	Fat mass	xxx.x (kg)	xxx.x (lb)	5
	Fat free mass	xxx.x (kg)	xxx.x (lb)	5
Left leg	Predicted muscle mass	xxx.x (kg)	xxx.x (lb)	5
	Body fat percentage	xx.x (%)	xx.x (%)	4
	Fat mass	xxx.x (kg)	xxx.x (lb)	5
	Fat free mass	xxx.x (kg)	xxx.x (lb)	5
Right arm	Predicted muscle mass	xxx.x (kg)	xxx.x (lb)	5
	Body fat percentage	xx.x (%)	xx.x (%)	4
	Fat mass	xxx.x (kg)	xxx.x (lb)	5
	Fat free mass	xxx.x (kg)	xxx.x (lb)	5
Left arm	Predicted muscle mass	xxx.x (kg)	xxx.x (lb)	5
	Body fat percentage	xx.x (%)	xx.x (%)	4
	Fat mass	xxx.x (kg)	xxx.x (lb)	5
	Fat free mass	xxx.x (kg)	xxx.x (lb)	5
Trunk	Predicted muscle mass	xxx.x (kg)	xxx.x (lb)	5
	Body fat percentage	xx.x (%)	xx.x (%)	4
	Fat mass	xxx.x (kg)	xxx.x (lb)	5
	Fat free mass	xxx.x (kg)	xxx.x (lb)	5
		xxx.x (kg)	xxx.x (lb)	5

⚠ Data will not be output if the [] key is used to switch to the body weight only mode.

⚠ Calculations are made using 1kcal = 4.184kJ.

(2) Output data format

Measurement data will be output in the following format.

A comma (,) is used as a separator between data items.

The terminators marking the end of data are CR (ASCII code: 0DH) and LF (ASCII code: 0AH).

If the digits in the data do not reach the stipulated length for fixed length data, the data will be right-justified for output, with a zero (0) (ASCII code: 30H) entered in any empty spaces.

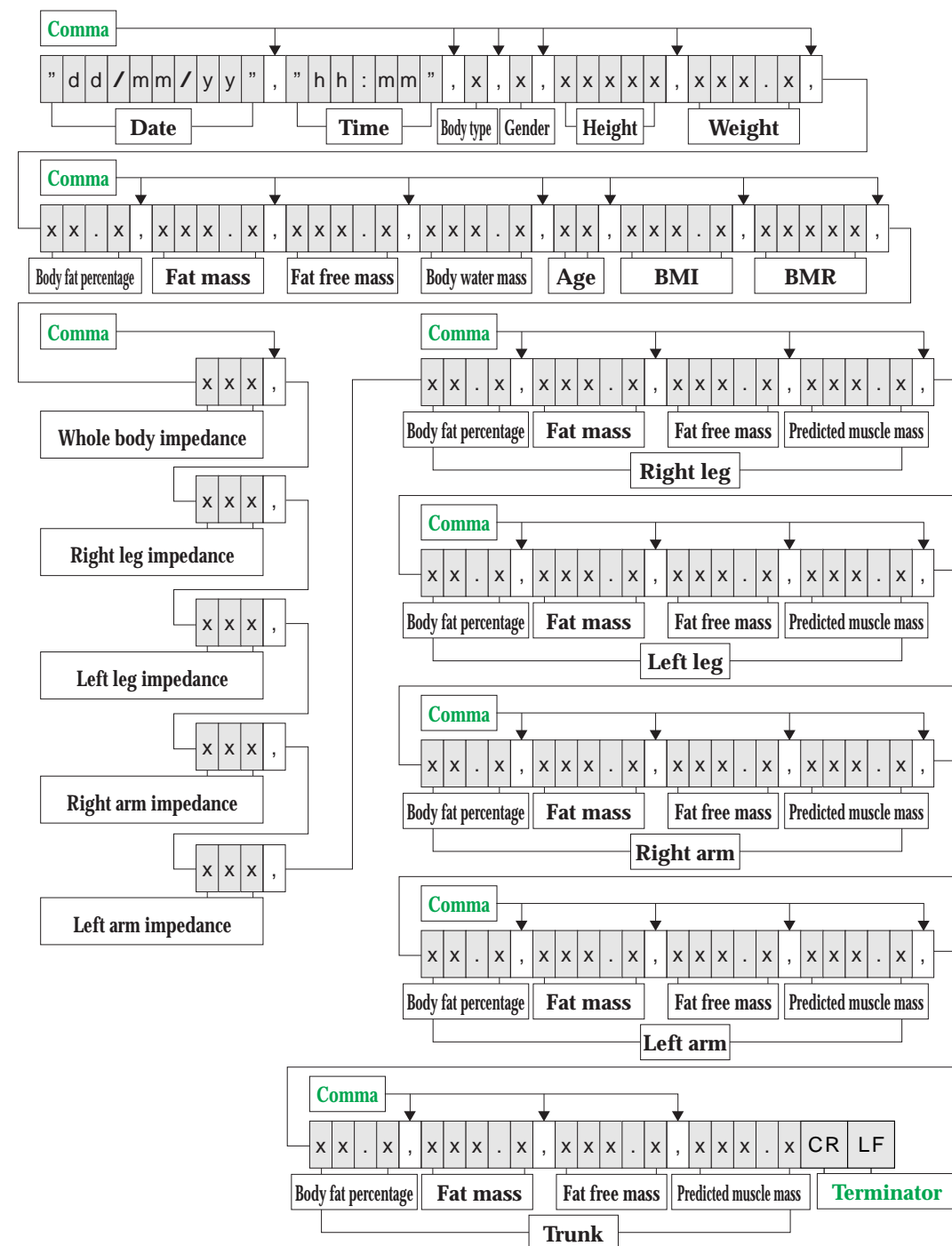

Output (Fat Monitor Mode) Format

Transmission Data

CAUTION The receiving PC must be ready to accept output data immediately after measurement is completed.

Output data

		Byte Length
Header	First byte	K: unit of weight kg L: unit of weight lb 1
	Second byte	S: stability of load (weight output) D: instability of load (weight output) I: overload status -: negative weight output 1
Weight		xxx.x 5

Output data format

- Terminal data are CR (ASCII format: 0DH), LF (ASCII format: 0AH).
- Measurement data will be sent in the format shown to the right:

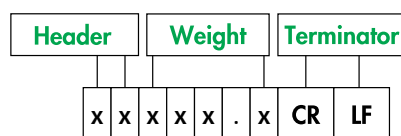

Remote Mode

All types of data may be entered by connecting the BF-350 to a PC and switching to Remote mode.

Switching to Remote Mode

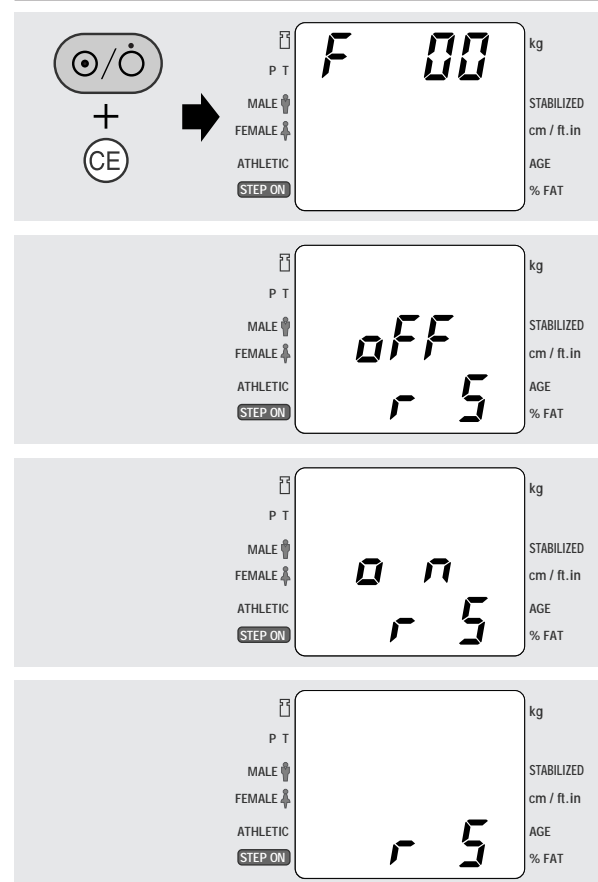

1. When the unit is switched off, press the [⊙/⊙] and [⊕] keys simultaneously.

Note The default setting is off.

2. Press [0], [8].

3. Switch Remote mode on and off by pressing [1] or [0].
[1] : Enables Remote mode
[0] : Disables Remote mode

4. Press [⊕] to confirm.
Only "r S" will appear (standby screen).

Note To switch off Remote mode, start from the beginning again and select "OFF" at Step 3.

Control Commands

When in Remote mode, the body fat analyzer may be operated remotely by sending control commands from a host.

commands [U]	U ? CR LF U 0 CR LF U 1 CR LF	U? : Confirm current setting U0: Use cm/kg mode U1: Use in/lb mode
commands [R]	R ? CR LF R 0 CR LF R 1 CR LF	R? : Confirm current setting R0: Select equation for Westerners R1: Select equation for Orientals
commands [D]	D ? CR LF D 0 X X X X . X CR LF D 1 X CR LF D 2 X CR LF D 3 X X X X X CR LF D 4 X X CR LF D 6 X X CR LF	D? : Confirm current setting D0 : Set clothing weight (5-byte fixed length) D1 : Set gender male = 1 female = 2 D2 : Set body type standard = 0 athlete = 2 D3 : Set height (5-byte fixed length) D4 : Set age (2-byte fixed length) D6 : Set Target BF (2-byte fixed length)
commands [G]	G 1 CR LF G 2 CR LF	G1: Start measuring body fat G2: Measure weight only
Special commands	CHR\$(01FH) CR LF	CHR\$(01FH): Reset settings

*All fixed-length data right aligned. Enter [0] for blanks.

Error Codes

If an error occurs, the body composition analyzer will send an error code to the host.

E 0 0 CR LF	E00 : Attempted to start measuring without completing settings
E 0 1 CR LF	E01 : Error in calculating body fat percentage
E X X CR LF	EXX :other error ' body fat analyzer switches off

*See p.26 "7. Troubleshooting" for details of errors.

Example of Use

The body composition analyzer is used remotely as follows.

1 Switch on body composition analyzer.

First, switch on the body composition analyzer.

 Check that the unit is in Remote mode.
Also check that the unit is connected properly to the computer.

2 Choose the units of measurement.

Ex: cm/kg

 Units of measurement cannot be set if tare weight and height have been set. The default setting is cm/kg.

Host ← **U 0 CR LF** →body composition analyzer

If commands received	Host ← U 0 CR LF — body composition analyzer
If settings incorrect	Host ← U ! CR LF — body composition analyzer

*If commands sent are unclear Host ← **! CR LF** commands returned

3 Select equation

Ex: equation for Westerners

 The default setting is the equation for Westerners

Host ← **R 0 CR LF** →body composition analyzer

If commands received	Host ← R 0 CR LF — body composition analyzer
If settings incorrect	Host ← R ! CR LF — body composition analyzer

4 Set tare weight

The tare weight need not be set if not required. It will then be treated as 0.

Ex: 1kg tare weight

Host ← **D 0 0 0 1 . 0 CR LF** →body composition analyzer

If commands received	Host ← D 0 CR LF — body composition analyzer
If settings incorrect	Host ← D ! CR LF — body composition analyzer

5 Set gender

Ex: male

Host ← **D 1 1 CR LF** →body composition analyzer

If commands accepted	Host ← D 1 CR LF — body composition analyzer
If settings incorrect	Host ← D 1 ! CR LF — body composition analyzer

6 Set body type

Ex: standard

Host ← **D 2 0 CR LF** →body composition analyzer

If commands accepted	Host ← D 2 CR LF — body composition analyzer
If settings incorrect	Host ← D 2 ! CR LF — body composition analyzer

7 Set height

Ex: 179cm

Host ← **D 3 0 0 1 7 9 CR LF** →body composition analyzer

If commands accepted	Host ← D 3 CR LF — body composition analyzer
If settings incorrect	Host ← D 3 ! CR LF — body composition analyzer

8 Set age

Ex: 34

Host ← **D 4 3 4 CR LF** →body composition analyzer

If commands accepted	Host ← D 4 CR LF — body composition analyzer
If settings incorrect	Host ← D 4 ! CR LF — body composition analyzer

9 Set target BF

Ex: 18%

Host ← **D 6 1 8 3 CR LF** →body composition analyzer

If commands accepted	Host ← D 6 CR LF — body composition analyzer
If settings incorrect	Host ← D 6 ! CR LF — body composition analyzer

10 Confirm settings

Host ← **D ? CR LF** →body composition analyzer

If commands accepted	Host ← D 0 0 0 1 . 0 CR LF — body composition analyzer
	Host ← D 1 1 CR LF — body composition analyzer
	Host ← D 2 0 CR LF — body composition analyzer
	Host ← D 3 0 0 1 7 9 CR LF — body composition analyzer
	Host ← D 4 3 4 CR LF — body composition analyzer
If settings incorrect	Host ← D 6 1 8 CR LF — body composition analyzer
	Host ← if data settings incorrect — body composition analyzer

*Gender, body type, height and age must be entered.

*Once all the necessary items of data have been entered, the unit will determine on the basis of age and gender whether to switch to Athlete or Standard mode.
Hence even if you choose Athlete mode, the unit may switch to Standard mode.

*If starting in Weight Only mode, only tare weight needs to be set.

11 Start measurement

Host ← G 1 CR LF → body composition analyzer

If commands accepted	Host ← G 1 CR LF — body composition analyzer
If settings incorrect	Host ← E 0 0 CR LF — body composition analyzer

12 During measurement

Commands are not accepted while measuring is in progress. If an error occurs, the body composition analyzer will transmit an error code to the host.

Host ← error code — body composition analyzer

13 Measurement finished

Readings will be outputted when measurement is finished.

If concluded normally	Host ← " 2 1 / 0 9 / 0 2 " , " 1 9 : 2 9 " , 0 , 1 , 0 0 1 7 9 , Date Time Body type Gender Height 0 7 3 . 3 , 1 3 . 1 , 0 0 9 . 6 , 0 6 3 . 7 , 0 4 6 . 6 , Weight Body fat percentage Fat mass Fat free mass Body water mass 3 4 , 0 2 3 . 9 , 0 7 2 9 4 , 5 5 1 , 2 1 2 , 2 1 4 , 2 9 2 , Age BMI BMR Whole body impedance Right leg impedance Left leg impedance Right arm impedance 3 0 9 , 0 8 . 9 , 0 0 1 . 1 , 0 1 1 . 5 , 0 1 0 . 9 , Left arm impedance Body fat percentage Fat mass Fat free mass Predicted muscle mass Right leg 1 0 . 1 , 0 0 1 . 2 , 0 1 1 . 0 , 0 1 0 . 4 , Body fat percentage Fat mass Fat free mass Predicted muscle mass Left leg 1 4 . 0 , 0 0 0 . 6 , 0 0 3 . 6 , 0 0 3 . 4 , Body fat percentage Fat mass Fat free mass Predicted muscle mass Right arm 1 5 . 4 , 0 0 0 . 6 , 0 0 3 . 5 , 0 0 3 . 3 , Body fat percentage Fat mass Fat free mass Predicted muscle mass Left arm 1 5 . 0 , 0 0 6 . 0 , 0 3 4 . 1 , 0 3 2 . 8 Body fat percentage Fat mass Fat free mass Predicted muscle mass Trunk CR LF — body composition analyzer Terminator
	If an error occurs

After measurement has finished, all necessary items of data and tare weight are cleared, and the unit waits for further commands.

Resetting

Reset settings

Host ← CHR\$(01FH) CR LF → body composition analyzer

If commands accepted : Host ← CHR\$(01FH) CR LF — body composition analyzer

If settings incorrect : Host ← ! CR LF — body composition analyzer

Technical Notes

GB

Reliability of body composition measurements with an 8-electrode BIA

Introduction

This device calculates body fat percentage, fat mass, fat free mass, and predicted muscle mass on the basis of data obtained by Dual Energy X-ray Absorptiometry (DXA) using Bioelectrical Impedance Analysis (BIA).

One of two settings must be selected when taking measurements:

- 1) Standard (for persons 7 ~ 99 years of age)
- 2) Athlete (sportsmen/women who exercise considerably more than non-athletes)

Making a distinction by body type in the measurement mode produces more reliable body composition measurements for athletes, whose body compositions differ from those of average persons.

Principles of body composition measurement via 8-electrode BIA

BIA is a means of measuring body composition – fat mass, predicted muscle mass, etc. – by measuring bioelectrical impedance in the body. Fat within the body allows almost no electricity to pass through, while electricity passes rather easily through water, much of which is found in muscles. The degree of difficulty with which electricity passes through a substance is known as the electrical resistance, and the percentage of fat and other body constituents can be inferred from measurements of this resistance.

The Tanita Body Composition Analyzer measures body composition using a constant current source with a high frequency current (50kHz, 500 μ A). The 8 electrodes are positioned so that electric current is supplied from the electrodes on the tips of the toes of both feet and the fingertips of both hands, and voltage is measured on the heel of both feet and the thenar side of both hands. The current flows into the upper limbs or lower limbs, depending on the body part(s) to be measured.

Body impedance measurement methods

In the conventional 4-electrode method, current is supplied from the electrodes at the tips of the toes on both feet, with the voltage measured on the heel. This current flows from one lower limb through the lower abdomen and then into the other lower limb, and the bioelectrical impedance (hereinafter, "impedance,") thus measured is the impedance between the two feet. In the newly developed 8-electrode method, however, current is supplied from the tips of the toes of both feet and the fingertips of both hands, and the voltage is measured on the heel of both feet and the thenar side of both hands. This method allows five different impedance measurements to be made – whole body, right leg, left leg, right arm, and left arm – by switching the part of the body in which the current is flowing and the location where the voltage is measured. When measuring impedance in the right leg, for instance, the current flows between the right hand and foot, and the voltage between both feet is measured.

For reference, the impedance measurement methods for the respective body parts are shown in the diagram below.

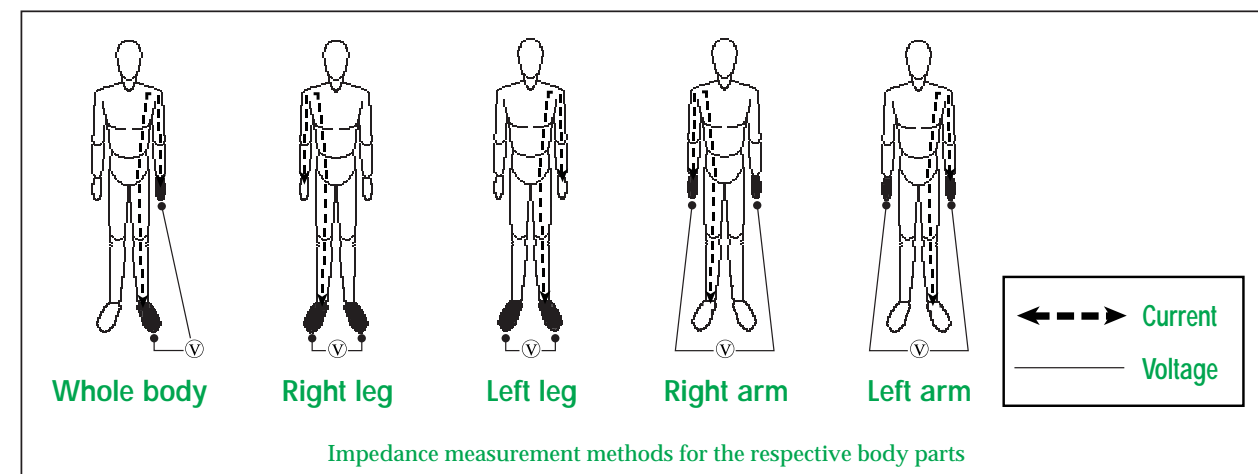

GB

Reliability of body composition analysis via 8-electrode BIA

In deriving the body fat percentage, fat mass, and fat free mass for the whole body, the Body Composition Analyzer uses data acquired by DXA* from both Japanese and Western subjects as well as a regression formula derived through repeated regression analysis using height, weight, age, and impedance between right hand and foot as variables. Measurements of body fat percentage, fat free mass, fat mass, and predicted muscle mass for specific body parts also use a regression formula for each body part derived from repeated regression analysis using height, weight, age, and impedance for individual body parts (right arm, left arm, right leg, left leg, trunk) as variables, based on data acquired through DXA.

A high degree of correlation has been found to exist between the figures for body fat percentage, fat mass, and fat free mass for individual parts and for the entire body calculated with this predictive formula and the figures obtained by DXA, and the results are thus highly reproducible.

Body composition measurements attained by the 8-electrode method are therefore extremely reliable.

Measurement of body composition using DXA

DXA was originally designed to measure bone mineral content, but in the full-body scan mode the body fat percentage, fat mass, and fat free mass of individual body parts (arms, legs, trunk) can also be measured. The image below shows one example of body composition measurement results obtained by DXA.

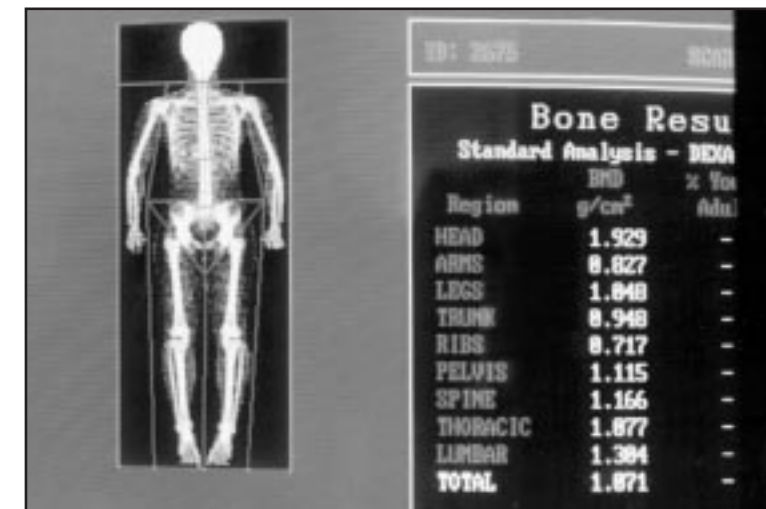

Body composition measurement results obtained by DXA (Lunar Co., Ltd; DPX-L)

Causes of errors in impedance measurements

BIA measures impedance and calculates body composition on the basis of this impedance. It is known, however, that impedance can vary due to changes in the quantity and distribution of body water, which accounts for approximately 60% of body weight, as well as changes in body temperature. Therefore, when measurements are being taken for research purposes or on a daily basis, uniform measurement conditions must be ensured.

Consideration should be given to two types of changes in impedance: inter-day changes and intra-day fluctuation (cyclic changes within a single day). In the 8-electrode method, full body measurements use the impedance between the arms and legs, while measurements for specific body parts use the impedance of those particular body parts.

The reasons for changes in impedance are different for the upper limbs and the lower limbs. Given that the impedance of the trunk is extremely low (a mere 5-10% of the impedance between hands and feet), changes involving the trunk can be almost wholly ignored when measuring the impedance between hands and feet, and the changes for the upper and lower limbs are synthesized.

When studying intra-day and inter-day changes with the 8-electrode method, it is thus necessary to determine the respective changes for the upper and lower limbs.

1) Intra-day fluctuations (cyclic activity within a single day)

Peripheral impedance ordinarily rises during sleep and falls during activity. This is believed to occur because extracellular fluid, typified by the blood, moves to the trunk during sleep, reducing the extracellular fluid in peripheral areas and thus increasing impedance, and because the extracellular fluid returns to peripheral areas during activity, causing a drop in impedance.

Intra-day activities during this cycle cause changes in body water volume and distribution due to the consumption of food and drink as well as exercise.

The charts on page 33 illustrate one example of intra-day activities. The changes in weight, impedance, and body fat percentage are shown on the respective vertical axes, while the measurement times are shown on the horizontal axes (plotted points indicate the variation from the average change).

Increases in body weight occurred following the consumption of food or drink, and a sharp decrease was seen between 20:00 and 22:00 because of a bath.

The impedance between the hands and feet, as mentioned earlier, synthesizes the changes in impedance of the upper limbs and the lower limbs.

During the two or three hours of digestion and absorption that followed breakfast and lunch, a decrease occurred in the impedance of both the upper and lower limbs, but the degree of change was larger in the lower limbs than in the upper limbs. This is because the impedance of the upper limbs temporarily increased due to the impact of specific dynamic action (SDA) from the meals but then turned downward as the body fluid mass increased. No such increase or decrease in impedance due to SDA was seen, though, in the lower limbs. After supper, the lower level of activity caused an increase due to lessened extracellular fluid in peripheral areas at the same time that upper and lower limb impedance fell due to digestion and absorption; as a result no clear trend could be seen.

Among the particularly large changes that occurred were decreases in impedance while taking baths and subsequent increases, increases and decreases attributable to exercise, and decreases after tasks such as carrying heavy objects that require use of the upper limbs. In the course of a single day, the largest intra-day change in the lower limbs was the decrease in impedance due to the flow of blood to the lower limbs (blood congestion). No clear trend was noted in impedance in the upper limbs over the course of a single day, but extremely large changes did occur as a result of certain activities in the daily routine.

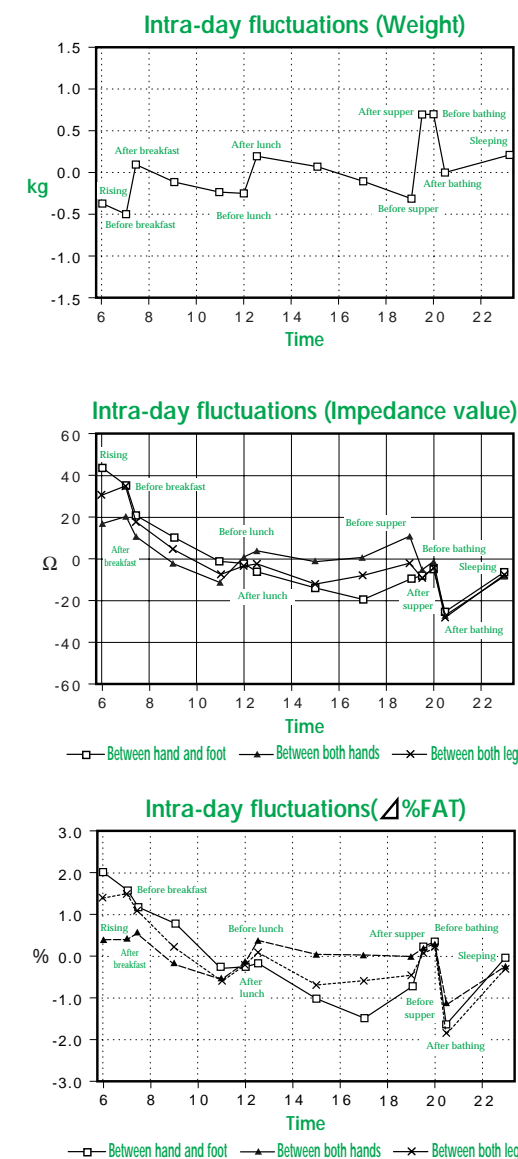

Intra-day changes are thought to occur in unique cycles arising from differences in the rhythm of individual daily routines, occupations, and day-to-day activities.

Consequently, to obtain consistent measurement figures it is recommended that measurements be taken under the following conditions:

- 1) Measuring three hours or more after waking up, with normal day-to-day activities carried on during this time (simply sitting or traveling by car will keep impedance high)
- 2) Measuring three hours or more after last eating (impedance tends to fall for 2 to 3 hours after a meal)
- 3) Measuring twelve or more hours after vigorous exercise (changes in impedance vary, depending on the type and intensity of the exercise done)
- 4) Urinating before the measurement
- 5) Measuring as far as possible at the same time every day in the case of repeated measurements (more dependable measurements can be obtained if body weight and impedance are both measured at fixed times)

Complying with the conditions above should result in very consistent measurements.

When developing this device, the following six conditions were established in deriving the regression formula:

- 1) No alcohol less than 12 hours prior to measurement
- 2) No vigorous exercise less than 12 hours prior to measurement
- 3) No excess food and drink on the day before measurement
- 4) No food and drink less than 3 hours prior to measurement
- 5) Urination immediately before measurement
- 6) No measurements during menstrual period (women)



2) Inter-day changes

The diagrams below offer examples of actual measurements made of inter-day changes. A study was done to determine the degree of change in the impedance between the feet during dehydration; the first two days represent a normal daily routine, while in the latter two days a state of dehydration was induced using a sauna.

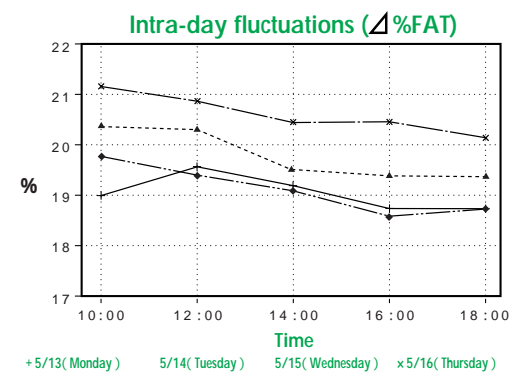
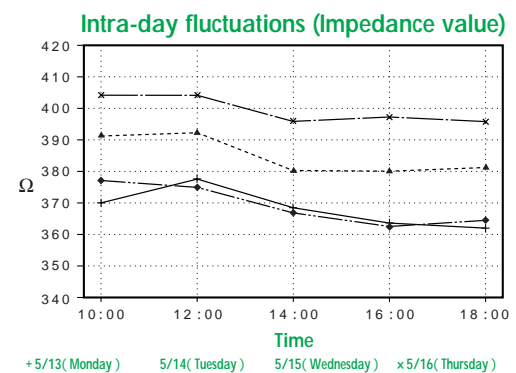
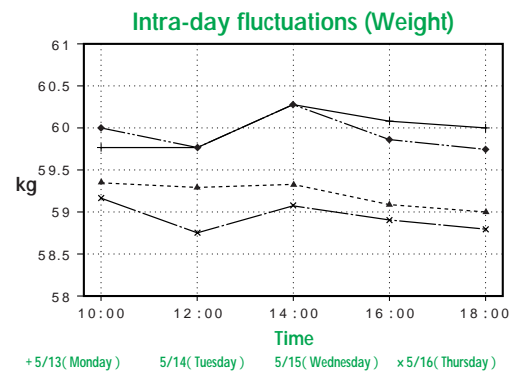

Inter-day changes in body fat percentage and impedance measured by BIA between the feet during normal daily routine and during dehydration

No significant inter-day change was measured in body weight, impedance between the feet, or body fat percentage during the normal daily routine. During the dehydrated state, however, a drop in body weight of 1kg was noted, with the impedance between the feet rising approximately 15Ω on the first day of dehydration and 30-35Ω on the second day. As a result, body fat percentage was up by around 1% on the first day of dehydration and by 1.5-2% on the second day.

As mentioned earlier, impedance increases when body weight is reduced (such as by dehydration), and decreases when body weight is increased through excess consumption of food and drink. The inter-day change in impedance is thus inversely proportional to the change in body weight.

These inter-day changes stem from such causes as:

- 1) Temporary increases in body weight (total body water) through overeating and overdrinking
- 2) Dehydration due to heavy sweating during vigorous exercise
- 3) Dehydration due to alcohol consumption or the use of diuretics
- 4) Dehydration due to heavy sweating during saunas, etc.

Accordingly, it is recommended that instructions be provided to the subject to help eliminate these causes when accurate measurements are needed.

THE APPLICABILITY OF THE OVERSEAS BMR REGRESSION FORMULA AND ITS DIFFERENCES WITH THE OLD FORMULA

The New Regression Formula for Basal Metabolic Rate (BMR)

It has long been said among medical and nutritional specialists that "The Basal Metabolic Rate (BMR) is more determined by the Fat Free Mass (FFM) than by the body weight" (Persons of a given body weight with a higher FFM will have a higher BMR), and that from the aspect of evaluating the body composition, should be estimated from the FFM. In addition, in cases of simple estimation formulae which can calculate from the height, weight and age, without evaluating the body composition, there was a problem with excessively high evaluations being given to obese persons with large body weight, and conversely excessively small BMR evaluations given to muscular athletes, though these are not as many in number. Currently, the BMR estimation recursion formula developed by Tanita, the manufacturer of body composition analyzers, based on their research, works by multiple regressive analysis using this FFM, and has a higher degree of accuracy in the individual differences in body composition. In order to derive the BMR, resting respiratory metabolism (Resting Energy Expenditure: REE) was measured using a breath gas analysis device, and this estimation recursion formula was created based on this data.

<Figure 1> The Relationship Between Resting Energy Expenditure (REE) According to Breath Gas Analysis and Weight, FFM

(Presented at Nutrition Week, Held in San Diego in 2002)

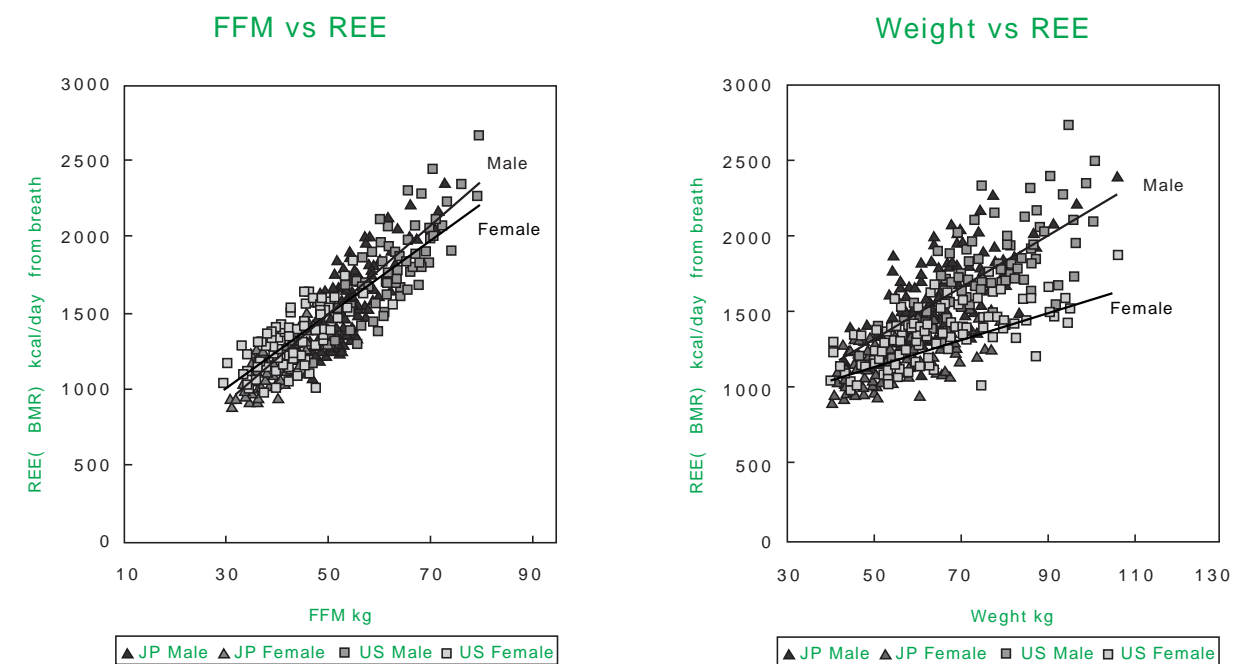



As shown in Figure 1: the REE (BMR) has a stronger relationship to the FFM than to body weight, and a difference is visible between males and females in the distribution trends. We see that in principle that we should calculate from the FFM rather than by the old formula centered on the relationship with weight.

<Fig. 2> Comparison of BMR Values from the TANITA Multiple regression model and Breath Analysis (Presented at Nutrition Week Held in San Diego in 2002)

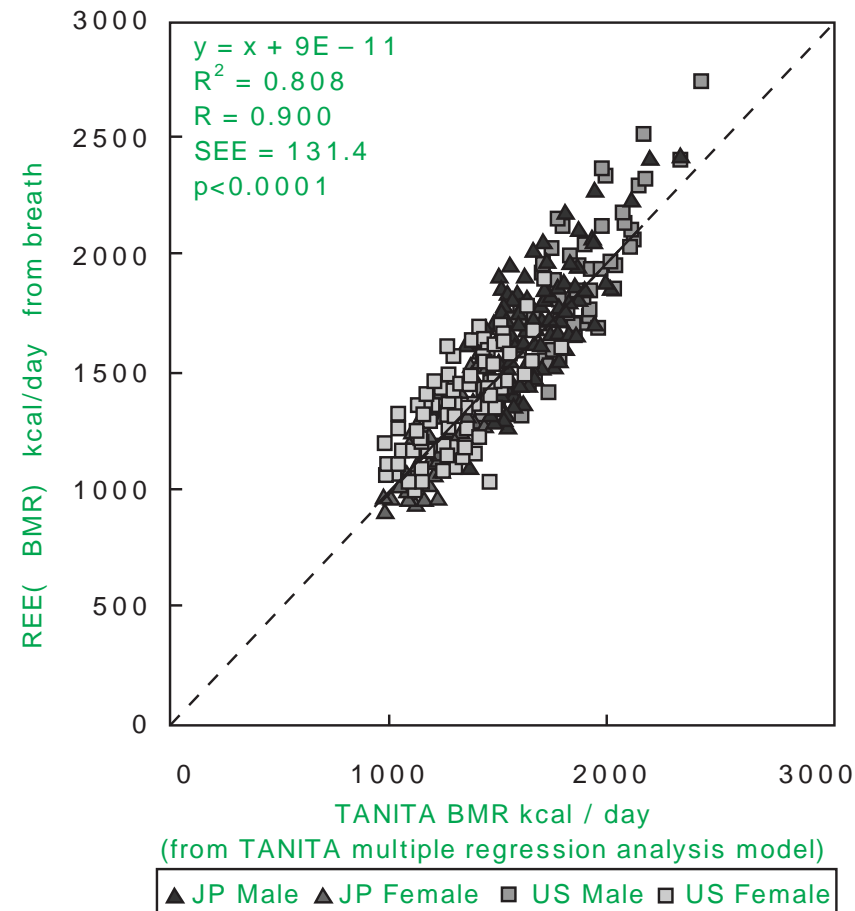

The current BMR retrogression formula is a formula which acts on the principle of using the FFM value from the results of body composition measurement according to the BIA. A good relationship is shown in the BMR value based on actual breath analysis REE or $R=0.9$ ($p < 0.0001$). These results were presented at the First Annual Nutrition Week (American College of Nutrition, American Society for Clinical Nutrition, American Society for Parenteral and Enteral Nutrition, North American Association for the Study of Obesity) held in 2002 in San Diego.

NOTE: This model has been calibrated for those between ages of 18-84.

Those individuals outside of this age range may not be obtain accurate readings.

Product specifications

		BF-418MA	
Accuracy Grade		MDD : CLASS II a MDD : CLASS III	
Power source		AC adaptor (included) Center Minus MODEL SA25-0535U CLASS 2 Input Voltage: 100-240 VAC 50/60 Hz 550mA Output Voltage: 5 VDC ± 0.3 V Rated Current: 3.5 A No Load Input Voltage: 5 VDC ± 0.3 V	
Power Consumption		17.5 W	
Impedance Measurement	Measurement System	8 polar Bioelectrical Impedance Analysis	
	Measurement Frequency	50kHz	
	Measurement Current	90µA	
	Electrode Material	Pressure Contact Stainless Steel Foot Pads, The Hand Grips are Metal-Plated to ABS Resin.	
	Measurement Style	Whole body, Right leg, Left leg, Right arm and Left arm	
	Measurement Range	150 ~ 1200Ω	
Accuracy at first calibration		12Ω	
Weight Measurement	Measurement System	Strain Gauge Load Cell	
	Maximum Capacity / Minimum Graduation	200 kg / 0.1 kg	
	Accuracy at first calibration	±0.2kg	
Input Items	Clothes Weight	0-200 kg / 9 st 13.8 lb / 440lb 0.1 kg increments	
	Gender	Male / Female	
	Body Type	Standard / Athletic	
	Age	7-99 years old / 1year increments	
	Height	90 - 249 cm 1 cm increments	
	Target Body Fat %	4-55%	
Output Items	Display	Target Body Fat %	4-55%
		Weight	0 - 200 kg 0.1 kg increments
		Gender	Male / Female
		Body Type	Standard / Athletic
		Age	7 - 99 years old / 1 year increments
		Height	90 - 249 cm 1 cm increments
	Print-out	FAT%	1 - 75% / 0.1% increments
		Body Type	Standard / Athletic
		Gender	Male / Female
		Age	7 - 99 years old / 1 year increments
		Height	90 - 249 cm 1 cm increments
		Weight	2 - 200 kg 0.1 kg increments
		BMI	0.1 increments
		BMR	1 kJ increments / 1 kcal increments
		Impedance ※1	150 ~ 1200 Ω / 1Ω increments
		FAT% ※2	1 - 75% / 0.1% increments
		Fat Mass ※2	0.1 kg increments
		FFM ※2	0.1 kg increments
		TBW	0.1 kg increments
		Predicted Weight	0.1 kg increments
		Predicted fat mass	0.1 kg increments
		FAT TO LOSE/GAIN	0.1 kg increments
		Predicted muscle Mass ※2	0.1 kg increments
		Others	Desirable Range for FAT% and FM (Standard and 20-79 years old ONLY)
Display		3 Rows, 5 Digits LCD	
Output Data Interface		RS-232C (D-sub 9 pins Female Connector)	
Temperature Range of Usage		0°C/35°C	
Relative Humidity		30% / 80% (without condensation)	
Weight of Equipment		12kg	
Size	Weighing Platform	340 X 375 X 90mm	
	Height	830mm	

※1 This item displays Whole Body, Right Leg, Left Leg, Right Arm and Left Arm.

※2 This item displays Right Leg, Left Leg, Right Arm, Left Arm and Trunk.